

Gıda Harici Reyon Parçaları
Non Food Shelving Parts

Gıda Harici Üniteler
Non Food Units

Akrobatlar
Acrobats

Gıda Harici Orta Standlar
Non Food Gondolas

Soyunma Kabini
Aynalar - Puflar
Fitting Cabinets & Mirrors
& Seat Groups



**KÜTAHYA PORSELEN
30 PARÇA YEMEK SETİ**

6 ADET 25 CM
SERVİS TABAĞI
6 ADET 22 CM
ÇUKUR TABAĞI
6 ADET 20 CM
PASTA TABAĞI
6 ADET
ÇAY FİNCANI
6 ADET
ÇAY FİNCANI TABAĞI

PROMOSYON
29.900 TL

paylaşılan

sofra

paylaşılan lezzet





pişirmek

KAZANCI ALIŞVERİŞ AYAGINCA BİSTNOKI

PROMOSYON
SOLO SUPER PÇETE
2.000 TL
1000 TL

EN
UCUZ
EN UCUZ

NER GÜN
EN DÜĞÜK
FİYAT



GIDA HARİCİ REYON PARÇALARI

Non Food Shelving Parts

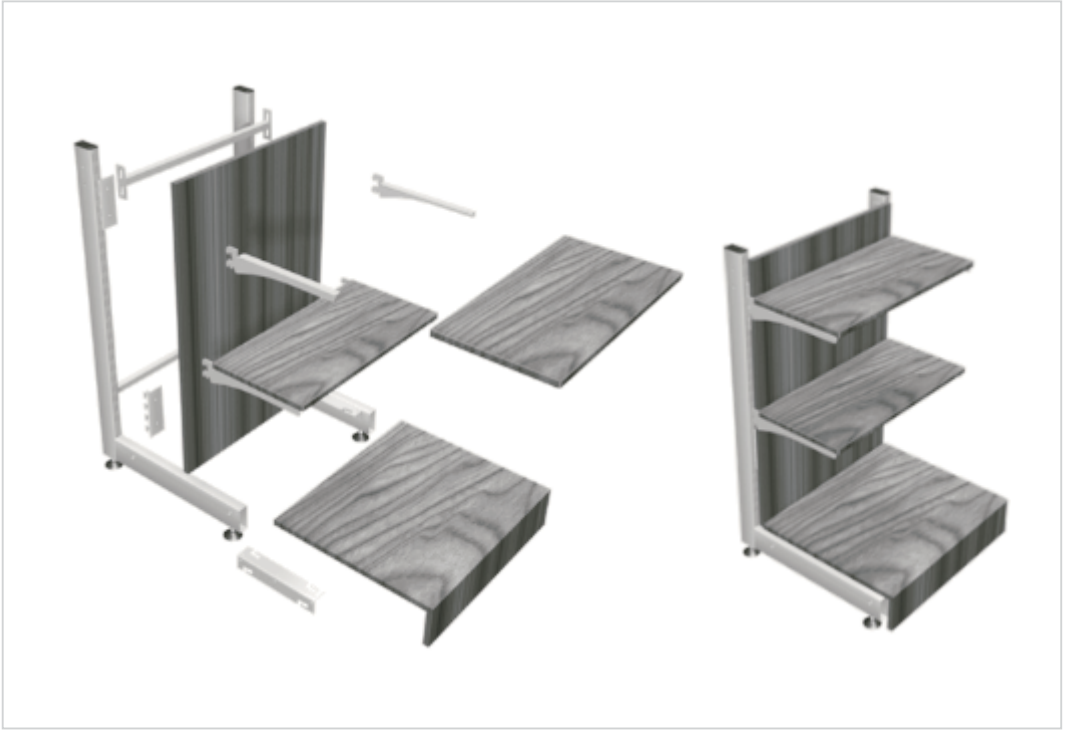

KAYNAKLI AYAK TEK YÖN - 30x60mm PH80mm

WELDED BASELEG - L - 30x60mm PH80mm
Main Code : U004 0001 00

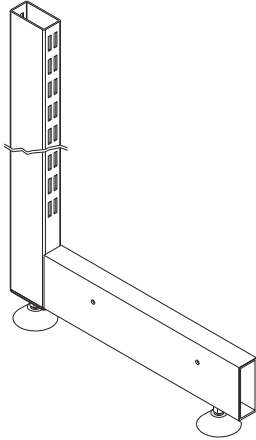

H	D	L
1010	300	30
1220	300	30
1430	300	30
1640	300	30
1850	300	30
2060	300	30
2270	300	30
1010	400	30
1220	400	30
1430	400	30
1640	400	30
1850	400	30
2060	400	30
2270	400	30
2480	400	30
1010	500	30
1220	500	30
1430	500	30
1640	500	30
1850	500	30
2060	500	30
2270	500	30
2480	500	30
H	D	L
1640	500	30
1850	500	30
2060	500	30
2270	500	30
2480	500	30

STN.R

KAYNAKLI AYAK TEK YÖN - 30x80mm PH80mm
WELDED BASELEG - L - 30x80mm PH80mm



KAYNAKLI AYAK ÇİFT YÖN - 30x60mm PH80mm

WELDED BASELEG - T - 30x60mm PH80mm
Main Code : U004 0002 00

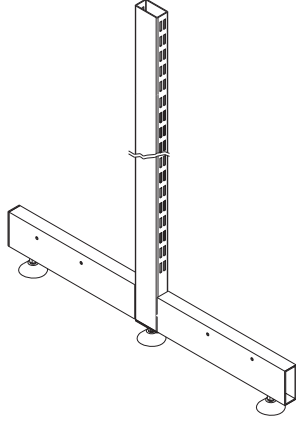

KAYNAKLI AYAK ÇİFT YÖN - 30x80mm PH80mm

WELDED BASELEG - T - 30x80mm PH80mm

KAYNAKLI AYAK TEK YÖN - ARB - 30x60mm PH80mm

WELDED BASELEG -L- WITH TIE BAR SLOTS - 30x60mm PH80mm
Main Code : U004 0005 00

* Option - Tekerlekli
- With wheels

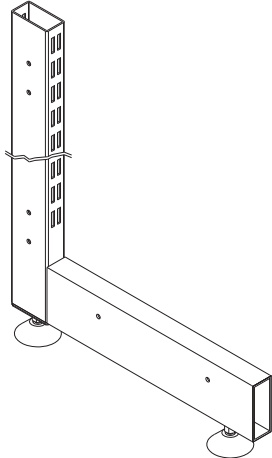

KAYNAKLI AYAK TEK YÖN - ARB - 30x80mm PH80mm

WELDED BASELEG -L- WITH TIE BAR SLOTS - 30x80mm PH80mm

Ölçü Dimension			Renk Color Code
H	D	L	STN.R
1010	300	30	
1220	300	30	
1430	300	30	
1640	300	30	
1850	300	30	
2060	300	30	
1010	400	30	
1220	400	30	
1430	400	30	
1640	400	30	
1850	400	30	
2060	400	30	
1010	500	30	
1220	500	30	
1430	500	30	
1640	500	30	
1850	500	30	
2060	500	30	
H	D	L	
1640	500	30	
1850	500	30	
2060	500	30	
H	D	L	
1010	300	30	
1220	300	30	
1430	300	30	
1640	300	30	
1850	300	30	
2060	300	30	
2270	300	30	
1010	400	30	
1220	400	30	
1430	400	30	
1640	400	30	
1850	400	30	
2060	400	30	
2270	400	30	
2480	400	30	
1010	500	30	
1220	500	30	
1430	500	30	
1640	500	30	
1850	500	30	
2060	500	30	
2270	500	30	
2480	500	30	
H	D	L	
1640	500	30	
1850	500	30	
2060	500	30	
2270	500	30	
2480	500	30	



UCGE SHOPFITTING & DESIGN

KAYNAKLI AYAK ÇİFT YÖN - ARB - 30x60mm PH80mm

WELDED BASELEG -T- WITH TIE BAR SLOTS - 30x60mm PH80mm

Main Code : U004 0006 00

* Option - Tekerlekli

~ With wheels

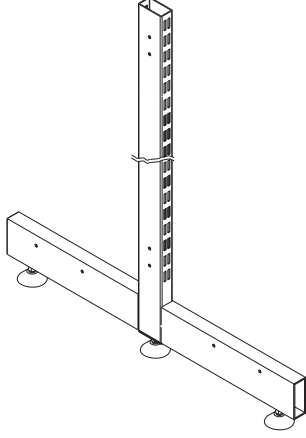

KAYNAKLI AYAK ÇİFT YÖN - ARB - 30x80mm PH80mm

WELDED BASELEG -T- WITH TIE BAR SLOTS - 30x80mm PH80mm

KAYNAKLI BORU AYAK TEK YÖN - Ø60mm

WELDED ROUND UPRIGHT - L - Ø60mm

Main Code : U004 0003 00

* Option - Tekerlekli

~ With wheels

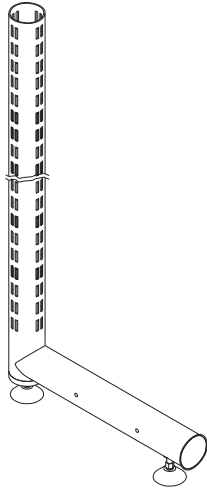

Ölçü Dimension			Renk Color Code
H	D	L	STN.R
1010	300	30	
1220	300	30	
1430	300	30	
1640	300	30	
1850	300	30	
2060	300	30	
1010	400	30	
1220	400	30	
1430	400	30	
1640	400	30	
1850	400	30	
2060	400	30	
1010	500	30	
1220	500	30	
1430	500	30	
1640	500	30	
1850	500	30	
2060	500	30	
H	D	L	
1640	500	30	
1850	500	30	
2060	500	30	
H	D	L	
1010	300	30	
1220	300	30	
1430	300	30	
1640	300	30	
1850	300	30	
2060	300	30	
2270	300	30	
1010	400	30	
1220	400	30	
1430	400	30	
1640	400	30	
1850	400	30	
2060	400	30	
2270	400	30	
2480	400	30	
1010	500	30	
1220	500	30	
1430	500	30	
1640	500	30	
1850	500	30	
2060	500	30	
2270	500	30	
2480	500	30	



ÜÇGE SHOPFITTING & DESIGN

KAYNAKLI BORU AYAK ÇİFT YÖN - Ø60mm

WELDED ROUND UPRIGHT - T - Ø60mm

Main Code : U004 0004 00

* Option - Tekerlekli

- With wheels

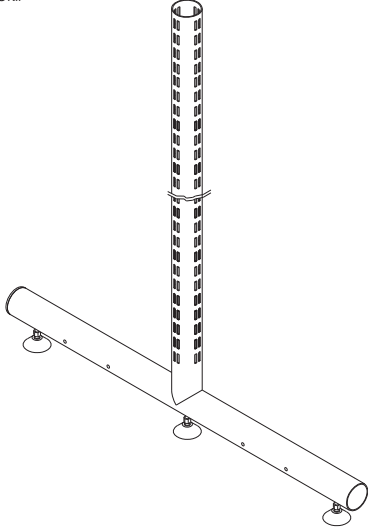

Ölçü
Dimension

Renk
Color Code

H	D	L
1010	300	30
1220	300	30
1430	300	30
1640	300	30
1850	300	30
2060	300	30
2270	300	30
1010	400	30
1220	400	30
1430	400	30
1640	400	30
1850	400	30
2060	400	30
2270	400	30
2480	400	30
1010	500	30
1220	500	30
1430	500	30
1640	500	30
1850	500	30
2060	500	30
2270	500	30
2480	500	30

STN.R

KAYNAKLI AYAK TEK YÖN - PROFİL P.AB - 30x60mm PH80mm

WELDED BASELEG L W Pro.Tie Sl.Wood.Base - 30x60mm PH80mm

Main Code : U004 0069 00

* Option - Tekerlekli

- With wheels

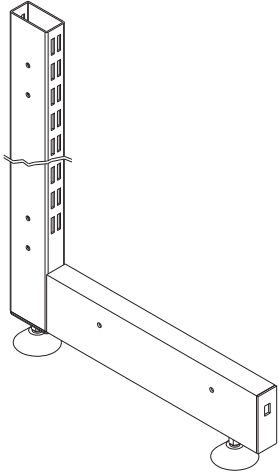

H	D	L
1010	300	30
1220	300	30
1430	300	30
1640	300	30
1850	300	30
2060	300	30
2270	300	30
1010	400	30
1220	400	30
1430	400	30
1640	400	30
1850	400	30
2060	400	30
2270	400	30
2480	400	30
1010	500	30
1220	500	30
1430	500	30
1640	500	30
1850	500	30
2060	500	30
2270	500	30
2480	500	30

STN.R



UCGE SHOPFITTING & DESIGN

KAY.AYAK ÇİFT YÖN - PROFİL P.AB - 30x60mm PH80mm

WELDED BASELEG T W Pro.Tie Sl.Wood.Base - 30x60mm PH80mm
Main Code : U004 0071 00

* Option - Tekerlekli
~ With wheels

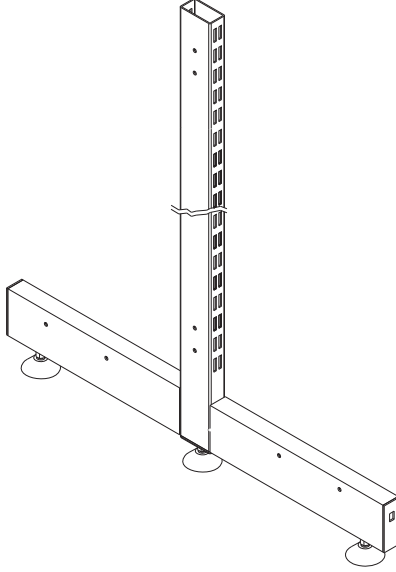

Ölçü Dimension			Renk Color Code
H	D	L	
1010	300	30	STN.R
1220	300	30	
1430	300	30	
1640	300	30	
1850	300	30	
2060	300	30	
1010	400	30	
1220	400	30	
1430	400	30	
1640	400	30	
1850	400	30	
2060	400	30	
1010	500	30	
1220	500	30	
1430	500	30	
1640	500	30	
1850	500	30	
2060	500	30	

KAY.AYAK TEK YÖN - PROFİL P.MB - 30x60mm PH80mm

WELDED BASELEG L W Pro.Tie Sl.Met.Base - 30x60mm PH80mm
Main Code : U004 0070 00

* Option - Tekerlekli
~ With wheels

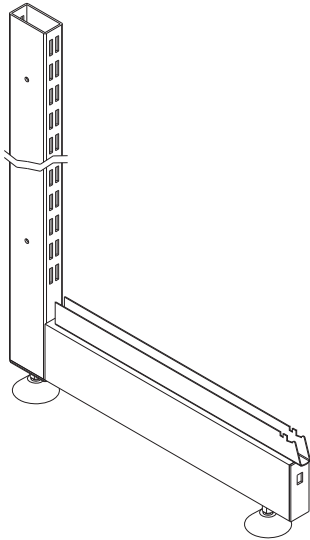

H	D	L	
1010	300	30	STN.R
1220	300	30	
1430	300	30	
1640	300	30	
1850	300	30	
2060	300	30	
2270	300	30	
1010	400	30	
1220	400	30	
1430	400	30	
1640	400	30	
1850	400	30	
2060	400	30	
2270	400	30	
2480	400	30	
1010	500	30	
1220	500	30	
1430	500	30	
1640	500	30	
1850	500	30	
2060	500	30	
2270	500	30	
2480	500	30	



ÜÇGE SHOPFITTING & DESIGN

KAY.AYAK ÇİFT YÖN - PROFİL P.MB - 30x60mm PH80mm

WELDED BASELEG T W Pro.Tie Sl.Meş.Base - 30x60mm PH80mm

Main Code : U004 0072 00

* Option - Tekerlekli
- With wheels

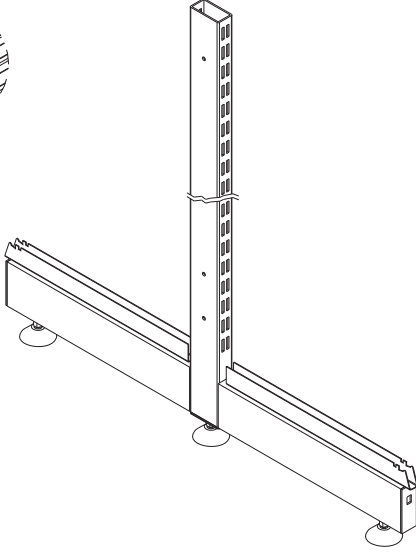
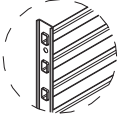

Ölçü Dimension			Renk Color Code
H	D	L	
1010	300	30	STN.R
1220	300	30	
1430	300	30	
1640	300	30	
1850	300	30	
2060	300	30	
1010	400	30	
1220	400	30	
1430	400	30	
1640	400	30	
1850	400	30	
2060	400	30	
1010	500	30	
1220	500	30	
1430	500	30	
1640	500	30	
1850	500	30	
2060	500	30	



ÜÇGE SHOPFITTING & DESIGN

PANEL DİKME ROTİLLİ

PANEL UPRIGHT WITH BOLT
Main Code : U003 0002 00

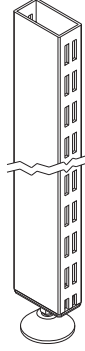

Ölçü Dimension			Renk Color Code
H	D	L	
1010	60	30	STN.R
1220	60	30	
1430	60	30	
1640	60	30	
1850	60	30	
2060	60	30	
2270	60	30	
2480	60	30	
1010	80	30	
1220	80	30	
1430	80	30	
1640	80	30	
1850	80	30	
2060	80	30	
2270	80	30	
2480	80	30	

PANEL DİKME ROTİLLİ - ARB

PANEL UPRIGHT WITH BOLT WITH TIE BAR SLOTS
Main Code : U003 0002 00 ARB



H	D	L	
1010	60	30	STN.R
1220	60	30	
1430	60	30	
1640	60	30	
1850	60	30	
2060	60	30	
2270	60	30	
2480	60	30	
1010	80	30	
1220	80	30	
1430	80	30	
1640	80	30	
1850	80	30	
2060	80	30	
2270	80	30	
2480	80	30	



UCGE SHOPFITTING & DESIGN

DİKME ÜST TAVAN ROTİL CIVATA

UPRIGHT CEILING MOUNTING SCREWS
Main Code : U003 0008 01

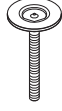

Ölçü Dimension			Renk Color Code
H	D	L	GLV
100	M10	55	
180	M10	55	

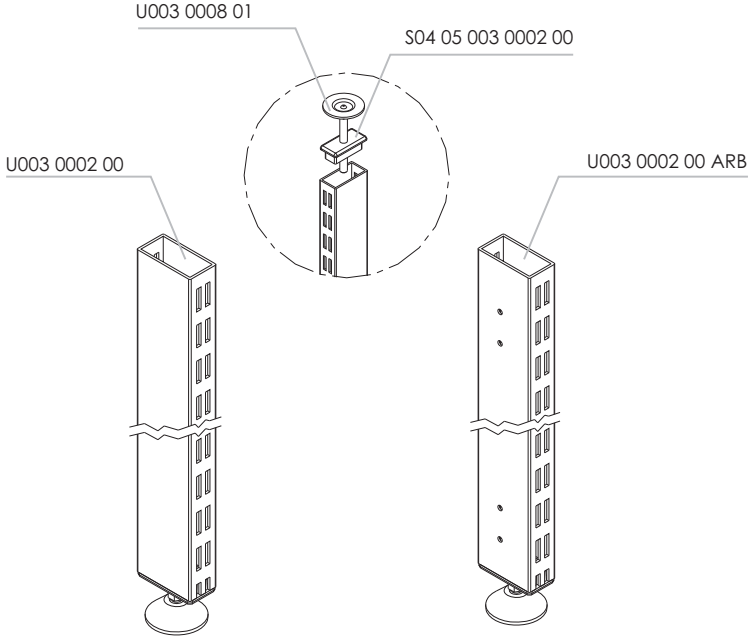

ROTİL CIVATA

ADJUSTABLE FOOT DISC
Main Code : S04 06 0010 01



H	D	L	GLV
60		M10	
100		M10	

ROTİL TAPA

ADJUSTABLE FOOT DISC PLASTIC
Main Code : S02 26 0900 00

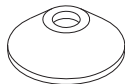

H	D	L	9005
20	55	55	



UCGE SHOPFITTING & DESIGN

PANEL DİKME ALT ROTİL TAPA

ADJUSTABLE FOOT DISC BOTTOM COVER
Main Code : S04 05 003 0002 00

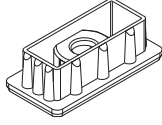

Ölçü Dimension			Renk Color Code
H	D	L	
35	60	30	
35	80	30	GLV
H	D	L	
30	280	80	GLV
H	D	L	
25	60	30	9010
25	80	30	7035
25	100	30	9005
H	D	L	
2	Ø60	60	7035
			9005
H	D	L	
60	Ø60	80	STN.A
H	D	L	
100	Ø60	70	STN.A

BAĞLANTI APARATI DUVARA MONTE

WALL FIXING
Main Code : U020 0003 00

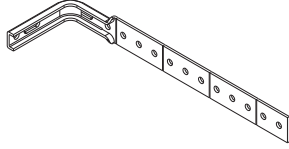

DİKME ÜST PLS TAPA

PLASTIC TOP CAP
Main Code : S02 26 0001 00



DİKME ÜST PLS TAPA - Ø60mm

PLASTIC TOP CAP ROUND - Ø60mm
Main Code : S02 26 0002 00



DİKME ÜST AHŞAP TAPA - Ø60mm - T5203

WOODEN TOP CAP ROUND
Main Code : S04 07 36 0052 03

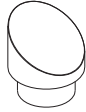

DİKME ÜST AHŞAP TAPA - Ø60mm - T5200

WOODEN TOP CAP
Main Code : S04 07 36 0052 00

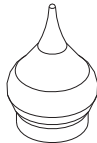



ARA BAĞLANTI

TIE BAR
Main Code : U020 0004 00

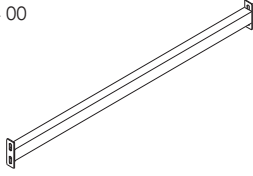

Ölçü
Dimension

Renk
Color Code

H	D	L
30	20	600
30	20	700
30	20	900

STN.R

ARA BAĞLANTI - BORU DİKME GEÇME

TIE BAR FOR ROUND UPRIGHT
Main Code : U020 0021 00

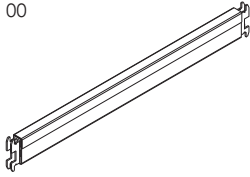

H	D	L
90	30	600
90	30	700
90	30	900

STN.R

ÜST SAC ARA BAĞLANTI

TIE BAR SHEET
Main Code : U020 0014 00

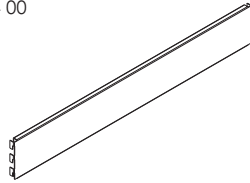

H	D	L
100		600
100		700
100		900

STN.R

ALT SAC AHŞAP TUTUCU

TIE BAR SHEET FOR WOODEN PANEL
Main Code : U020 0040 00

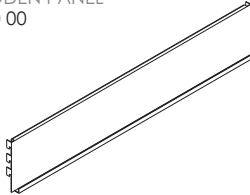

H	D	L
125		600
125		700
125		900

STN.R

AHŞAP PANO TIRNAĞI

WOODEN PANEL HANDLES
Main Code : U020 0013 00

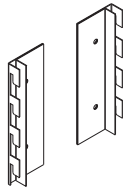

H	D	L
140		45

CNK

KLIPS AHŞAP TUTUCU

MIRROR HOLDER CLIP
Main Code : S07 10 001 14 - 18mm

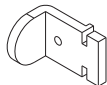

ADET
PIECES

SYD



ÜÇGE SHOPFITTING & DESIGN

ARKA PANO AHŞAP - SUNTALAM

WOODEN PANEL PLAIN - CHIPBOARD

Main Code : U002 0008 00 DP - SLM

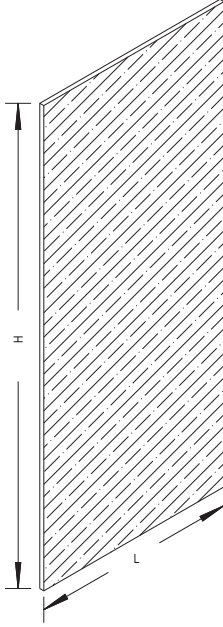

Ölçü Dimension			Renk Color Code
H	D	L	
1010	18	600	STN.A
1010	18	700	
1010	18	900	
1220	18	600	
1220	18	700	
1220	18	900	
1430	18	600	
1430	18	700	
1430	18	900	
1640	18	600	
1640	18	700	
1640	18	900	
1850	18	600	
1850	18	700	
1850	18	900	
2060	18	600	
2060	18	700	
2060	18	900	
2270	18	600	
2270	18	700	
2270	18	900	
2480	18	600	
2480	18	700	
2480	18	900	

ARKA PANO AHŞAP - MDFLAM

WOODEN PANEL PLAIN - MDFLAM

Main Code : U002 0008 00 DP- MLM

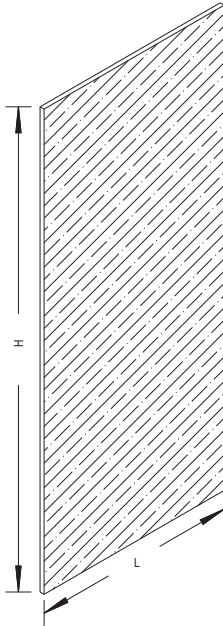

H	D	L	
1010	18	600	STN.A
1010	18	700	
1010	18	900	
1220	18	600	
1220	18	700	
1220	18	900	
1430	18	600	
1430	18	700	
1430	18	900	
1640	18	600	
1640	18	700	
1640	18	900	
1850	18	600	
1850	18	700	
1850	18	900	
2060	18	600	
2060	18	700	
2060	18	900	
2270	18	600	
2270	18	700	
2270	18	900	
2480	18	600	
2480	18	700	
2480	18	900	



ARKA PANO AHŞAP KANALLI - KA 200mm - SUNTALAM

WOODEN SLATWALL 200mm in dif.- CHIPBOARD
Main Code : U002 0008 00 KP - SLM

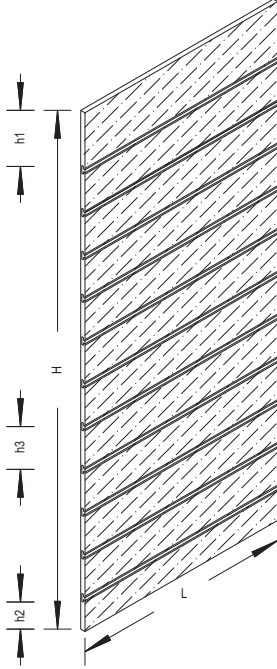

Ölçü Dimension			Renk Color Code
H	D	L	
1010	18	600	STN.A
1010	18	700	
1010	18	900	
1220	18	600	
1220	18	700	
1220	18	900	
1430	18	600	
1430	18	700	
1430	18	900	
1640	18	600	
1640	18	700	
1640	18	900	
1850	18	600	
1850	18	700	
1850	18	900	
2060	18	600	
2060	18	700	
2060	18	900	
2270	18	600	
2270	18	700	
2270	18	900	
2480	18	600	
2480	18	700	
2480	18	900	

ARKA PANO AHŞAP KANALLI - KA 100mm - SUNTALAM

WOODEN SLATWALL 100mm in dif.- CHIPBOARD
Main Code : U002 0008 00 KP - SLM

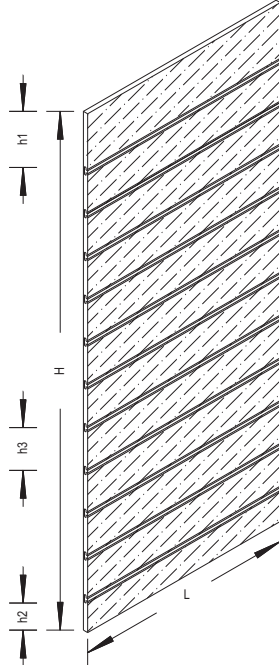

H	D	L	
1010	18	600	STN.A
1010	18	700	
1010	18	900	
1220	18	600	
1220	18	700	
1220	18	900	
1430	18	600	
1430	18	700	
1430	18	900	
1640	18	600	
1640	18	700	
1640	18	900	
1850	18	600	
1850	18	700	
1850	18	900	
2060	18	600	
2060	18	700	
2060	18	900	
2270	18	600	
2270	18	700	
2270	18	900	
2480	18	600	
2480	18	700	
2480	18	900	

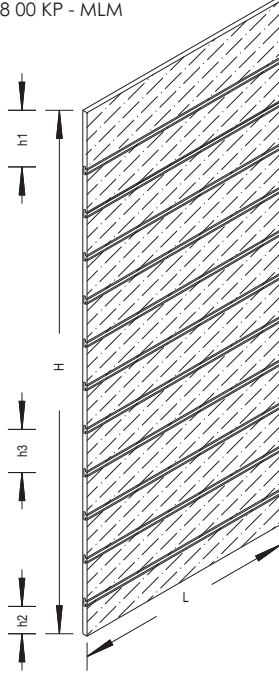
**ARKA PANO AHŞAP KANALLI - KA 200mm - MDFLAM**WOODEN SLATWALL 200mm in dif. - MDFLAM
Main Code : U002 0008 00 KP - MLM

Ölçü Dimension			Renk Color Code
H	D	L	
1010	18	600	STN.A
1010	18	700	
1010	18	900	
1220	18	600	
1220	18	700	
1220	18	900	
1430	18	600	
1430	18	700	
1430	18	900	
1640	18	600	
1640	18	700	
1640	18	900	
1850	18	600	
1850	18	700	
1850	18	900	
2060	18	600	
2060	18	700	
2060	18	900	
2270	18	600	
2270	18	700	
2270	18	900	
2480	18	600	
2480	18	700	
2480	18	900	

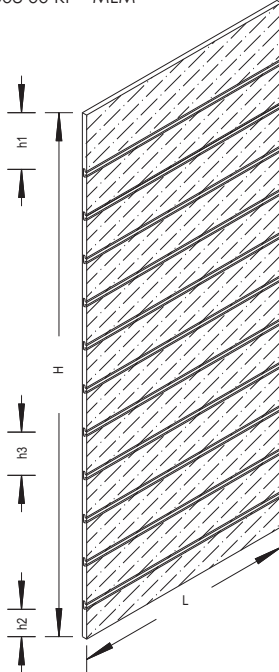
ARKA PANO AHŞAP KANALLI - KA 100mm - MDFLAMWOODEN SLATWALL 100mm in dif. - MDFLAM
Main Code : U002 0008 00 KP - MLM

H	D	L	
1010	18	600	STN.A
1010	18	700	
1010	18	900	
1220	18	600	
1220	18	700	
1220	18	900	
1430	18	600	
1430	18	700	
1430	18	900	
1640	18	600	
1640	18	700	
1640	18	900	
1850	18	600	
1850	18	700	
1850	18	900	
2060	18	600	
2060	18	700	
2060	18	900	
2270	18	600	
2270	18	700	
2270	18	900	
2480	18	600	
2480	18	700	
2480	18	900	



ÜÇGE SHOPFITTING & DESIGN

AHŞAP PANO ÜSTÜ BANT - SUNTALAM

WOODEN TOP PANEL - CHIPBOARD
Main Code : U002 0044 00 SLM

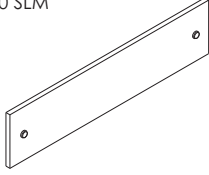

Ölçü Dimension			Renk Color Code
H	D	L	
100	18	600	STN.A
100	18	700	
100	18	900	
200	18	600	
200	18	700	
200	18	900	

AHŞAP PANO ÜSTÜ BANT - MDFLAM

WOODEN TOP PANEL - MDFLAM
Main Code : U002 0044 00 MLM

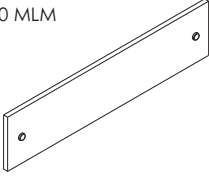

H	D	L	
100	18	600	STN.A
100	18	700	
100	18	900	
200	18	600	
200	18	700	
200	18	900	

AHŞAP PANO ÜSTÜ BANT - T0087

TOP PANEL METAL - T0087
Main Code : U0025 0087 00

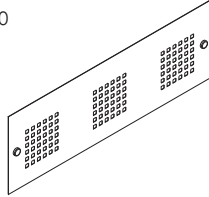

H	D	L	
100		600	STN.R
100		700	
100		900	
200		600	
200		700	
200		900	

ALT SAC AYNA TUTUCU

MIRROR HOLDER BOTTOM
Main Code : U020 0040 00

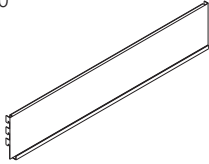

H	D	L	
125		600	STN.R
125		700	
125		900	

ÜST SAC AYNA TUTUCU

MIRROR HOLDER TOP
Main Code : U020 0014 00

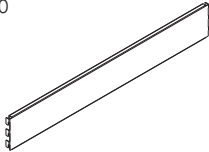

H	D	L	
100		600	STN.R
100		700	
100		900	

KLIPS AYNA TUTUCU

MIRROR HOLDER CLIP
Main Code : S07 10 001 14 - 4mm

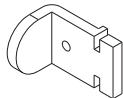

ADET PIECES			
			SYD



ARKA PANO AYNA

MIRROR BACK PANEL

Main Code : U002 0047 00

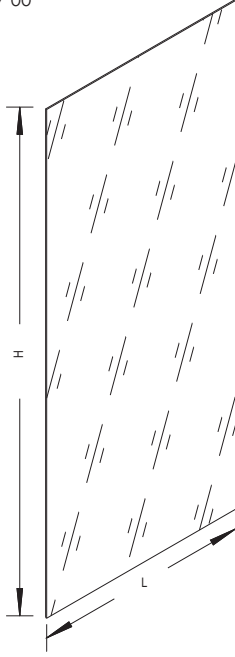

Ölçü Dimension			Renk Color Code
H	D	L	
1220	4	600	FLA
1220	4	700	
1220	4	900	
1430	4	600	
1430	4	700	
1430	4	900	
1640	4	600	
1640	4	700	
1640	4	900	
1850	4	600	
1850	4	700	
1850	4	900	
2060	4	600	
2060	4	700	
2060	4	900	
2270	4	600	
2270	4	700	
2270	4	900	
2480	4	600	
2480	4	700	
2480	4	900	

ARKA PANO AYNA - KENAR KUMLU

MIRROR BACK PANEL CORNER SANDBLASTED

Main Code : U002 0209 00

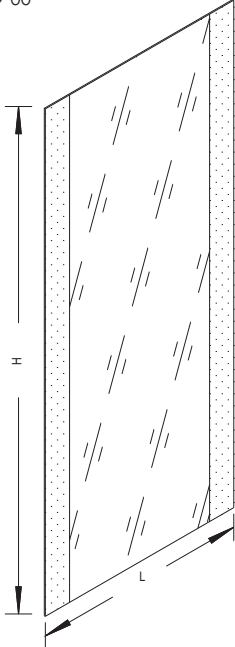

H	D	L	
1220	4	600	FLA SYDB
1220	4	700	
1220	4	900	
1430	4	600	
1430	4	700	
1430	4	900	
1640	4	600	
1640	4	700	
1640	4	900	
1850	4	600	
1850	4	700	
1850	4	900	
2060	4	600	
2060	4	700	
2060	4	900	
2270	4	600	
2270	4	700	
2270	4	900	
2480	4	600	
2480	4	700	
2480	4	900	



ARKA PANO KUMLU CAM

BACK PANEL SANDBLASTED GLASS
Main Code : U002 0061 00

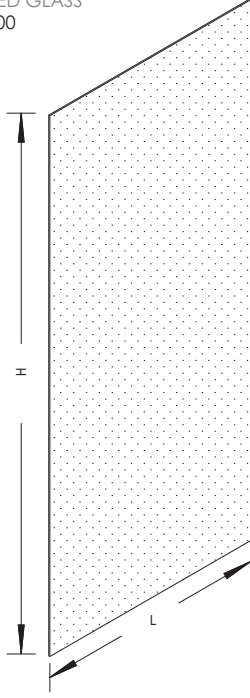

Ölçü Dimension			Renk Color Code
H	D	L	
1220	4	600	SYDB
1220	4	700	
1220	4	900	
1430	4	600	
1430	4	700	
1430	4	900	
1640	4	600	
1640	4	700	
1640	4	900	
1850	4	600	
1850	4	700	
1850	4	900	
2060	4	600	
2060	4	700	
2060	4	900	
2270	4	600	
2270	4	700	
2270	4	900	
2480	4	600	
2480	4	700	
2480	4	900	

ARKA PANO PLEKSİ

ACRYLIC BACK PANEL
Main Code : U002 0046 00

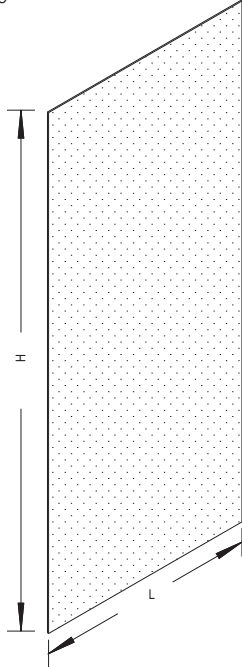

H	D	L	
1220	4	600	SYDB
1220	4	700	
1220	4	900	
1430	4	600	
1430	4	700	
1430	4	900	
1640	4	600	
1640	4	700	
1640	4	900	
1850	4	600	
1850	4	700	
1850	4	900	
2060	4	600	
2060	4	700	
2060	4	900	
2270	4	600	
2270	4	700	
2270	4	900	
2480	4	600	
2480	4	700	
2480	4	900	



ÜÇGE SHOPFITTING & DESIGN

ARKA PANO AYDINLATMA TK.

BACK PANEL ILLUMINATION SET
Main Code : U075 004 DIK002

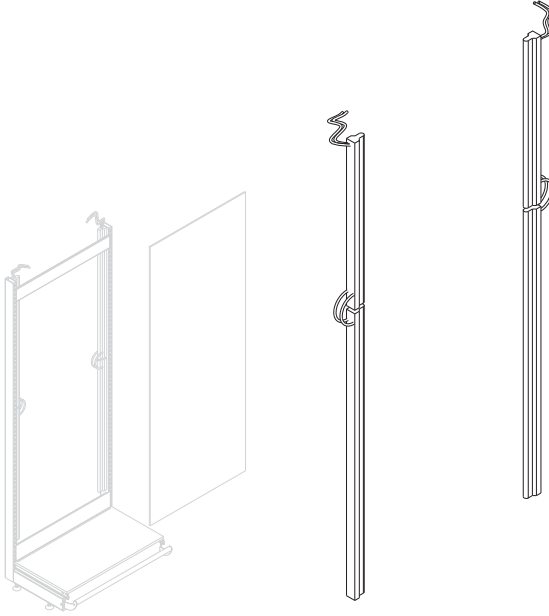

Ölçü Dimension			Renk Color Code
H	D	L	
1220			
1430			
1640			
1850			
2060			
2270			

AYNA ÜST BANT - T0033

MIRROR TOP PANEL - T0033
Main Code : U025 0033 00

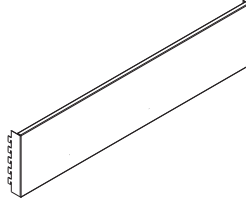

H	D	L	
100		600	
100		700	
100		900	
200		600	STN.R
200		700	
200		900	

AYNA ÜST BANT - T0012

MIRROR TOP PANEL - T0012
Main Code : U015 0012 00

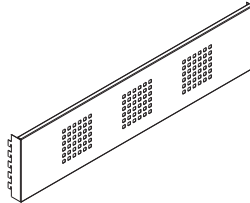

H	D	L	
100		600	
100		700	
100		900	
200		600	STN.R
200		700	
200		900	

AHŞAP PANO TIRNAĞI - AYNA ÜSTÜ

WOODEN PANEL HANDLES - OVER MIRROR
Main Code : U020 0133 00

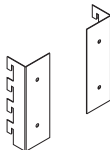

H	D	L	
200		45	CNK



AYNA ÜST BANT - T0202

MIRROR TOP PANEL - T0202
Main Code : U016 0202 00

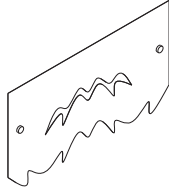

Ölçü Dimension			Renk Color Code
H	D	L	
420		600	STN.R
420		700	
420		900	

AYNA ÜST BANT - T0203 - ALT

MIRROR TOP PANEL - T0203 - SUBSECTION
Main Code : U016 0203 00

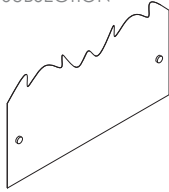

H	D	L	
420		600	STN.R
420		700	
420		900	

AYNA ÜST BANT - T0034

MIRROR TOP PANEL - T0034
Main Code : U015 0034 00

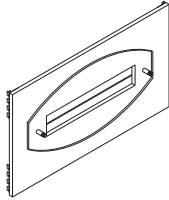

H	D	L	
500		900	STN.A SYDB

PROFİL ARKA PANO

BACK PANEL PROFILE
Main Code : U002 0116 00

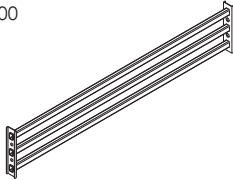

H	D	L	
210		600	STN.R
210		700	
210		900	
210		1000	
210		1250	
210		1330	

PROFİL ARKA PANO

BACK PANEL PROFILE
Main Code : U002 0116 00

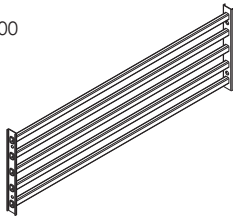

H	D	L	
420		600	STN.R
420		700	
420		900	
420		1000	
420		1250	
420		1330	



ÜÇGE SHOPFITTING & DESIGN

PODYUM ÖN PANO

PLINTH

Main Code : U015 0001 00

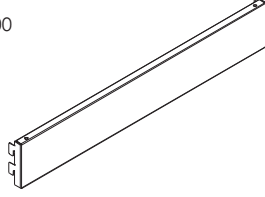
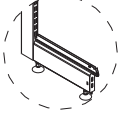

Ölçü Dimension			Renk Color Code
H	D	L	
120		600	STN.R
120		700	
120		900	
H	D	L	
Ø 32		600	NKL
Ø 32		700	
Ø 32		900	
H	D	L	
45	45	250	CNK
H	D	L	
Ø 32		600	NKL
Ø 32		700	
Ø 32		900	
H	D	L	
Ø 32		600	NKL
Ø 32		700	
Ø 32		900	
H	D	L	
45	45	250	CNK

PODYUM ÖN TAMPON

BUMPER

Main Code : U039 0001 00

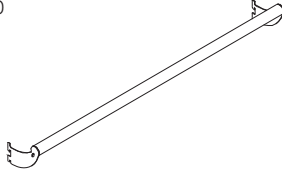
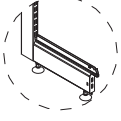

AYAK KLİT SACI - GEÇME AYAK

BASELEG LOCK STEEL - GA

Main Code : U070 0058 03

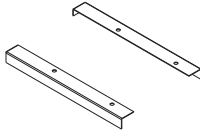
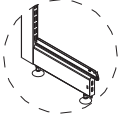

PODYUM ÖN TAMPON - T0028

FRONT BARRIER - T0028

Main Code : U039 0028 00

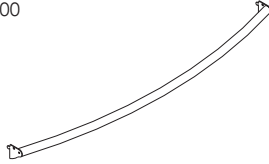
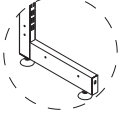

PODYUM ÖN TAMPON - T0050

FRONT BARRIER - T0050

Main Code : U039 0050 00

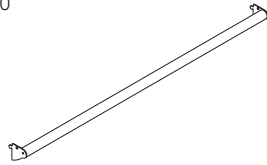
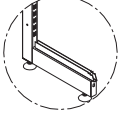

AYAK KLİT SACI - KAYNAK AYAK

BASELEG LOCKING STEEL - FOR WELDED BASELEG

Main Code : U004 0009 00

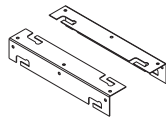



ÜÇGE SHOPFITTING & DESIGN

AHŞAP ALT RAF - SUNTALAM

WOODEN BASE SHELF CHIPBOARD

Main Code : U005 0004 00 SLM

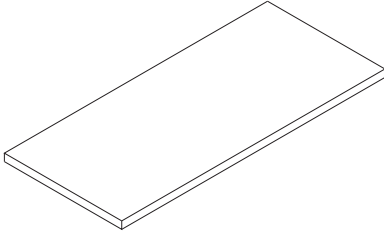

Ölçü Dimension			Renk Color Code
H	D	L	STN.A
18	300	600	
18	300	700	
18	300	900	
18	400	600	
18	400	700	
18	400	900	
18	500	600	
18	500	700	
18	500	900	
SAĞ - RIGHT			
18	300	615	
18	300	715	
18	300	915	
18	400	615	
18	400	715	
18	400	915	
18	500	615	
18	500	715	
18	500	915	
SOL - LEFT			
18	300	615	
18	300	715	
18	300	915	
18	400	615	
18	400	715	
18	400	915	
18	500	615	
18	500	715	
18	500	915	
Tekli - Singles			
18	300	630	
18	300	730	
18	300	930	
18	400	630	
18	400	730	
18	400	930	
18	500	630	
18	500	730	
18	500	930	



ÜÇGE SHOPFITTING & DESIGN

AHŞAP ALT RAF - MDFLAM

WOODEN BASE SHELF MDFLAM
Main Code : U005 0004 00 MLM

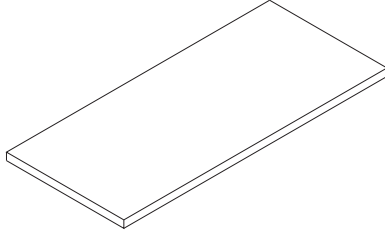

Ölçü Dimension			Renk Color Code
H	D	L	
18	300	600	STN.A
18	300	700	
18	300	900	
18	400	600	
18	400	700	
18	400	900	
18	500	600	
18	500	700	
18	500	900	
SAĞ - RIGHT			
18	300	615	
18	300	715	
18	300	915	
18	400	615	
18	400	715	
18	400	915	
18	500	615	
18	500	715	
18	500	915	
SOL - LEFT			
18	300	615	
18	300	715	
18	300	915	
18	400	615	
18	400	715	
18	400	915	
18	500	615	
18	500	715	
18	500	915	
Tekli - Singles			
18	300	630	
18	300	730	
18	300	930	
18	400	630	
18	400	730	
18	400	930	
18	500	630	
18	500	730	
18	500	930	



ÜÇGE SHOPFITTING & DESIGN

AHŞAP ALT RAF ÖN ALIN - SUNTALAM

WOODEN PLINTH CHIPBOARD
Main Code : U015 0003 00 SLM

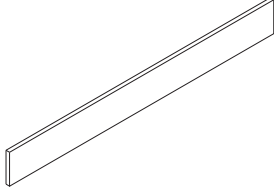

AHŞAP ALT RAF ÖN ALIN - MDFLAM

WOODEN PLINTH MDFLAM
Main Code : U015 0003 00 MLM

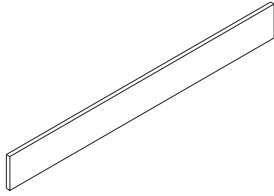

Ölçü Dimension			Renk Color Code
H	D	L	STN.A
110	18	600	
110	18	700	
110	18	900	
SAĞ - RIGHT			
110	18	615	
110	18	715	
110	18	915	
SOL - LEFT			
110	18	615	
110	18	715	
110	18	915	
Tekli - Singles			
110	18	630	
110	18	730	
110	18	930	
H	D	L	STN.A
110	18	600	
110	18	700	
110	18	900	
SAĞ - RIGHT			
110	18	615	
110	18	715	
110	18	915	
SOL - LEFT			
110	18	615	
110	18	715	
110	18	915	
Tekli - Singles			
110	18	630	
110	18	730	
110	18	930	

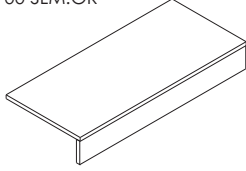
**AHŞAP ALT RAF BAZA - SUNTALAM - ORTA**WOODEN BASE SHELF CHIPBOARD - MIDDLE
Main Code : U005 0149 00 SLM.OR

Ölçü Dimension			Renk Color Code
H	D	L	
130	300	600	STN.A
130	300	700	
130	300	900	
130	400	600	
130	400	700	
130	400	900	
130	500	600	
130	500	700	
130	500	900	
H	D	L	
130	300	635	STN.A
130	300	735	
130	300	935	
130	400	635	
130	400	735	
130	400	935	
130	500	635	
130	500	735	
130	500	935	
H	D	L	
130	300	635	STN.A
130	300	735	
130	300	935	
130	400	635	
130	400	735	
130	400	935	
130	500	635	
130	500	735	
130	500	935	
H	D	L	
130	300	670	STN.A
130	300	770	
130	300	970	
130	400	670	
130	400	770	
130	400	970	
130	500	670	
130	500	770	
130	500	970	

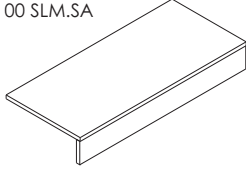
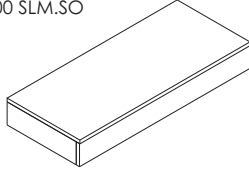
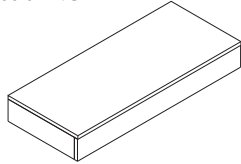
AHŞAP ALT RAF BAZA - SUNTALAM - SAĞWOODEN BASE SHELF CHIPBOARD - RIGHT
Main Code : U005 0149 00 SLM.SA**AHŞAP ALT RAF BAZA - SUNTALAM - SOL**WOODEN BASE SHELF CHIPBOARD - LEFT
Main Code : U005 0149 00 SLM.SO**AHŞAP ALT RAF BAZA - SUNTALAM - TEKLİ**WOODEN BASE SHELF CHIPBOARD - SINGLE
Main Code : U005 0149 00 SLM.GB



AHŞAP ALT RAF BAZA - MDFLAM - ORTA

WOODEN BASE SHELF MDFLAM - MIDDLE
Main Code : U005 0149 00 MLM.OR

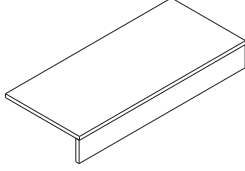

Ölçü Dimension			Renk Color Code
H	D	L	
130	300	600	STN.A
130	300	700	
130	300	900	
130	400	600	
130	400	700	
130	400	900	
130	500	600	
130	500	700	
130	500	900	

AHŞAP ALT RAF BAZA - MDFLAM - SAĞ

WOODEN BASE SHELF MDFLAM - RIGHT
Main Code : U005 0149 00 MLM.SA

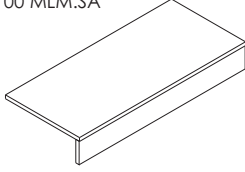

H	D	L	
130	300	635	STN.A
130	300	735	
130	300	935	
130	400	635	
130	400	735	
130	400	935	
130	500	635	
130	500	735	
130	500	935	

AHŞAP ALT RAF BAZA - MDFLAM - SOL

WOODEN BASE SHELF MDFLAM - LEFT
Main Code : U005 0149 00 MLM.SO

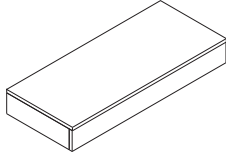

H	D	L	
130	300	635	STN.A
130	300	735	
130	300	935	
130	400	635	
130	400	735	
130	400	935	
130	500	635	
130	500	735	
130	500	935	

AHŞAP ALT RAF BAZA - MDFLAM - TEKLİ

WOODEN BASE SHELF CHIPBOARD - SINGLE
Main Code : U005 0149 00 MLM.GB

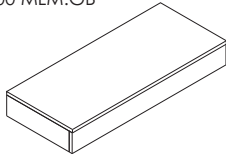

H	D	L	
130	300	670	STN.A
130	300	770	
130	300	970	
130	400	670	
130	400	770	
130	400	970	
130	500	670	
130	500	770	
130	500	970	



UCGE SHOPFITTING & DESIGN

AHŞAP ALT RAF - SUNTALAM

WOODEN BASE SHELF CHIPBOARD

Main Code : U005 0078 00 SLM

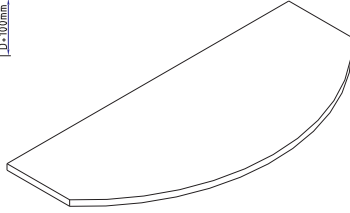
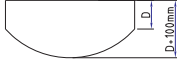

Ölçü Dimension			Renk Color Code
H	D	L	
18	300	600	STN.A
18	300	700	
18	300	900	
18	400	600	
18	400	700	
18	400	900	
18	500	600	
18	500	700	
18	500	900	
SAĞ - RIGHT			
18	300	615	
18	300	715	
18	300	915	
18	400	615	
18	400	715	
18	400	915	
18	500	615	
18	500	715	
18	500	915	
SOL - LEFT			
18	300	615	
18	300	715	
18	300	915	
18	400	615	
18	400	715	
18	400	915	
18	500	615	
18	500	715	
18	500	915	
Tekli - Singles			
18	300	630	
18	300	730	
18	300	930	
18	400	630	
18	400	730	
18	400	930	
18	500	630	
18	500	730	
18	500	930	



ÜÇGE SHOPFITTING & DESIGN

AHŞAP ALT RAF OVAL - MDFLAM

WOODEN BASE SHELF MDFLAM

Main Code : U005 0078 00 MLM

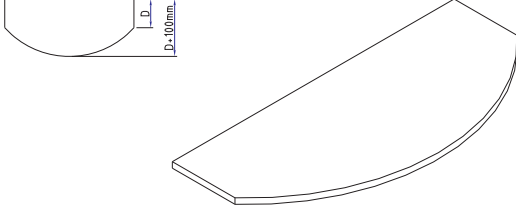

Ölçü Dimension			Renk Color Code
H	D	L	
18	300	600	STN.A
18	300	700	
18	300	900	
18	400	600	
18	400	700	
18	400	900	
18	500	600	
18	500	700	
18	500	900	
SAĞ - RIGHT			
18	300	615	
18	300	715	
18	300	915	
18	400	615	
18	400	715	
18	400	915	
18	500	615	
18	500	715	
18	500	915	
SOL - LEFT			
18	300	615	
18	300	715	
18	300	915	
18	400	615	
18	400	715	
18	400	915	
18	500	615	
18	500	715	
18	500	915	
Tekli - Singles			
18	300	630	
18	300	730	
18	300	930	
18	400	630	
18	400	730	
18	400	930	
18	500	630	
18	500	730	
18	500	930	



ÜÇGE SHOPFITTING & DESIGN

KONSOL AHŞAP RAF

WOODEN SHELF BRACKET

Main Code : U007 0010 00 AR

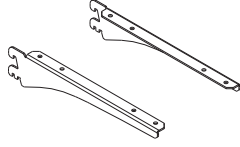

Ölçü Dimension			Renk Color Code
H	D	L	
	300 400 500		STN.R
H	D	L	
	300 300 300 400 400 400 500 500 500	600 700 900 600 700 900 600 700 900	STN.R
H	D	L	
	300 300 300 400 400 400 500 500 500	600 700 900 600 700 900 600 700 900	STN.R
H	D	L	
18 18 18 18 18 18 18 18 18 18 18	300 300 300 350 350 350 400 400 400 500 500 500	600 700 900 600 700 900 600 700 900 600 700 900	STN.A
H	D	L	
18 18 18 18 18 18 18 18 18 18 18	300 300 300 350 350 350 400 400 400 500 500 500	600 700 900 600 700 900 600 700 900 600 700 900	STN.A

KONSOL AHŞAP RAF - DESTEKLİ

WOODEN SHELF BRACKET WITH SUPPORT

Main Code : U042 0012 00 AR

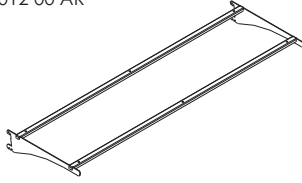

KONSOL AHŞAP RAF - DESTEKLİ - AĞIR YÜK

WOODEN SHELF BRACKET WITH SUPPORT HEAVY DUTY

Main Code : U042 0001 00 AR

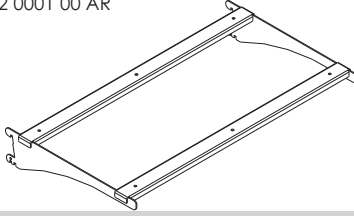

AHŞAP ÜST RAF - SUNTALAM

WOODEN TOP SHELF CHIPBOARD

Main Code : U005 0005 00 SLM

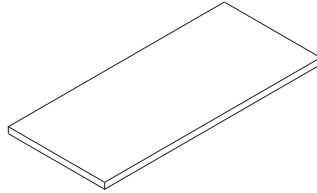

AHŞAP ÜST RAF - MDFLAM

WOODEN TOP SHELF MDFLAM

Main Code : U005 0005 00 MLM

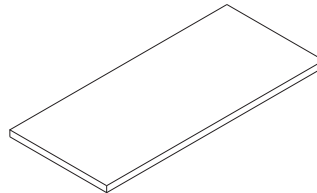



ÜÇGE SHOPFITTING & DESIGN

AHŞAP ÜST RAF OVAL - SUNTALAM

WOODEN TOP SHELF CHIPBOARD

Main Code : U005 0123 00 SLM

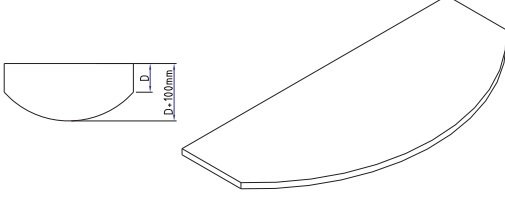

Ölçü Dimension			Renk Color Code
H	D	L	
18	300	600	STN.A
18	300	700	
18	300	900	
18	350	600	
18	350	700	
18	350	900	
18	400	600	
18	400	700	
18	400	900	
18	500	600	
18	500	700	
18	500	900	

AHŞAP ÜST RAF OVAL - MDFLAM

WOODEN TOP SHELF MDFLAM

Main Code : U005 0123 00 MLM

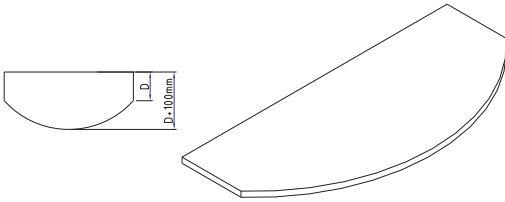

H	D	L	
18	300	600	STN.A
18	300	700	
18	300	900	
18	350	600	
18	350	700	
18	350	900	
18	400	600	
18	400	700	
18	400	900	
18	500	600	
18	500	700	
18	500	900	

AHŞAP ÜST RAF ALINLI - SUNTALAM

WOODEN TOP SHELF CHIPBOARD

Main Code : U005 0260 00 SLM

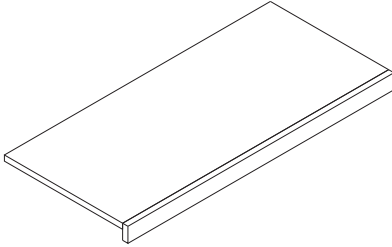

H	D	L	
18	300	600	STN.A
18	300	700	
18	300	900	
18	350	600	
18	350	700	
18	350	900	
18	400	600	
18	400	700	
18	400	900	
18	500	600	
18	500	700	
18	500	900	

AHŞAP ÜST RAF ALINLI - MDFLAM

WOODEN TOP SHELF MDFLAM

Main Code : U005 0260 00 MLM

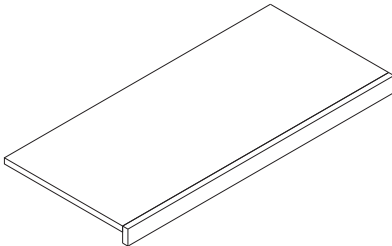

H	D	L	
18	300	600	STN.A
18	300	700	
18	300	900	
18	350	600	
18	350	700	
18	350	900	
18	400	600	
18	400	700	
18	400	900	
18	500	600	
18	500	700	
18	500	900	



ÜÇGE SHOPFITTING & DESIGN

AHŞAP ÜST RAF EG.AL - SUNTALAM

WOODEN TOP SHELF CHIPBOARD

Main Code : U005 0057 00 SLM

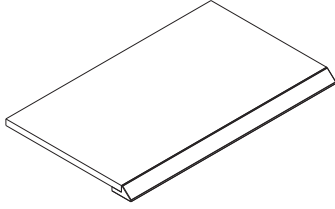

Ölçü Dimension			Renk Color Code
H	D	L	
18	300	600	STN.A
18	300	700	
18	300	900	
18	350	600	
18	350	700	
18	350	900	
18	400	600	
18	400	700	
18	400	900	
18	500	600	
18	500	700	
18	500	900	

AHŞAP ÜST RAF EG.AL - MDFLAM

WOODEN TOP SHELF MDFLAM

Main Code : U005 0057 00 MLM

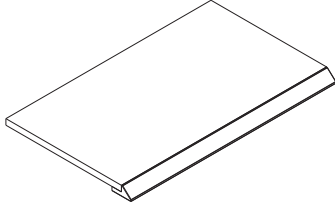

H	D	L	
18	300	600	STN.A
18	300	700	
18	300	900	
18	350	600	
18	350	700	
18	350	900	
18	400	600	
18	400	700	
18	400	900	
18	500	600	
18	500	700	
18	500	900	

AHŞAP ÜST RAF - SUNTALAM - ÖN TEL UYGULAMALI

WOODEN TOP SHELF CHIPBOARD USED WITH GRID

Main Code : U005 0118 00 SLM

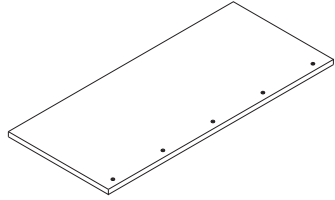

H	D	L	
18	300	600	STN.A
18	300	700	
18	300	900	
18	350	600	
18	350	700	
18	350	900	
18	400	600	
18	400	700	
18	400	900	
18	500	600	
18	500	700	
18	500	900	

AHŞAP ÜST RAF - MDFLAM - ÖN TEL UYGULAMALI

WOODEN TOP SHELF MDFLAM USED WITH GRID

Main Code : U005 0118 00 MLM

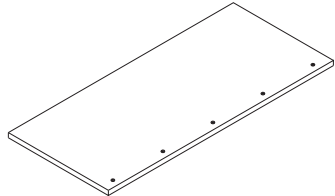

H	D	L	
18	300	600	STN.A
18	300	700	
18	300	900	
18	350	600	
18	350	700	
18	350	900	
18	400	600	
18	400	700	
18	400	900	
18	500	600	
18	500	700	
18	500	900	



KONSOL CAM RAF

GLASS SHELF BRACKET
Main Code : U007 0010 00 CR

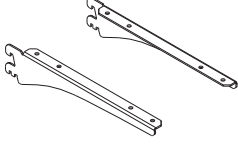

Ölçü Dimension			Renk Color Code	
H	D	L		
	300 400 500		STN.A	
H	D	L		
	300 300 300	600 700 900	STN.R	
	400 400 400	600 700 900		
	500 500 500	600 700 900		
H	D	L		
	300 300 300	600 700 900		STN.R
	400 400 400	600 700 900		
	500 500 500	600 700 900		

KONSOL CAM RAF - DESTEKLİ

GLASS SHELF BRACKET WITH SUPPORT
Main Code : U042 0012 00 CR

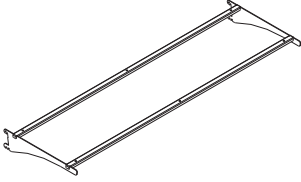

KONSOL CAM RAF - DESTEKLİ - AĞIR YÜK

GLASS SHELF BRACKET WITH SUPPORT HEAVY DUTY
Main Code : U042 0001 00 CR

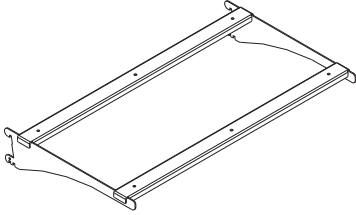



CAM RAF

GLASS SHELF

Main Code : U005 0018 00 DU

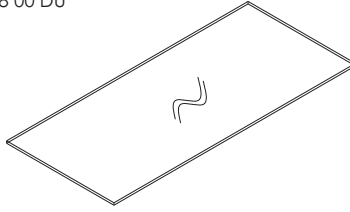

Ölçü Dimension			Renk Color Code
H	D	L	
8	300	600	SYD
8	300	700	
8	300	900	
8	400	600	
8	400	700	
8	400	900	
8	500	600	
8	500	700	
8	500	900	

CAM RAF - KUMLU

SANDED GLASS SHELF SANDBLASTED

Main Code : U005 0018 00 KU

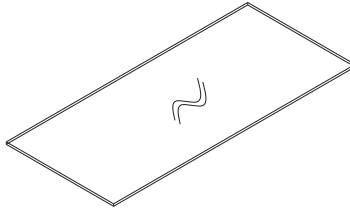

H	D	L	
8	300	600	SYDB
8	300	700	
8	300	900	
8	400	600	
8	400	700	
8	400	900	
8	500	600	
8	500	700	
8	500	900	

CAM RAF OVAL

GLASS SHELF OVAL

Main Code : U005 0019 00 DU

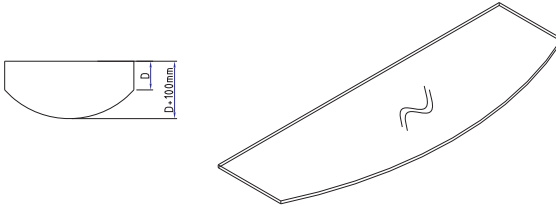

H	D	L	
8	300	600	SYD
8	300	700	
8	300	900	
8	400	600	
8	400	700	
8	400	900	
8	500	600	
8	500	700	
8	500	900	

CAM RAF OVAL - KUMLU

SANDED GLASS SHELF OVAL SANDBLASTED

Main Code : U005 0019 00 KU

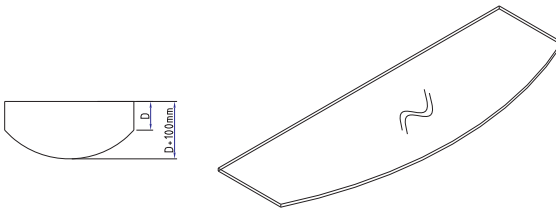

H	D	L	
8	300	600	SYDB
8	300	700	
8	300	900	
8	400	600	
8	400	700	
8	400	900	
8	500	600	
8	500	700	
8	500	900	



ÜÇGE SHOPFITTING & DESIGN

AHŞAP RAF ETİKETİ - GEÇME

WOODEN SHELF LABEL
Main Code : U005 0034 00

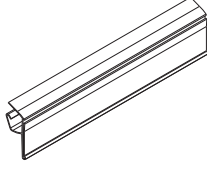

Ölçü Dimension			Renk Color Code
H	D	L	
42		100	SYD
42		600	
42		700	
42		900	
H	D	L	
42		100	SYD
42		600	
42		700	
42		900	
H	D	L	
40		600	NKL
40		700	
40		900	

CAM RAF ETİKETİ - GEÇME

GLASS SHELF LABEL
Main Code : U005 0032 00

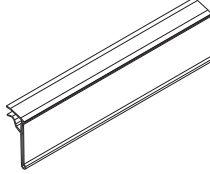

AHŞAP RAF ÖN TEL

WOODEN SHELF FRONT GRID
Main Code : U010 0040 00

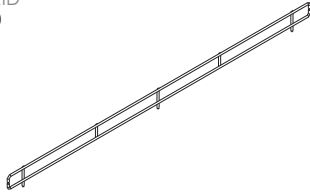



BAZA ÜSTÜ DOLAP - KAPAKLI

CUPBOARD OVER BASE

Main Code : U055 0263 00 AK



* Option - Kilit ~ Lock

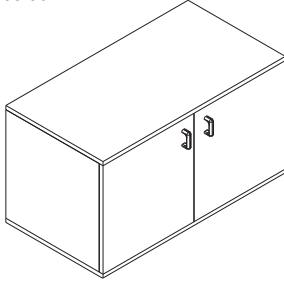

H	D	L	
500	400	600	STN.A
500	400	700	
500	400	900	
500	500	600	
500	500	700	
500	500	900	

BAZA ÜSTÜ DOLAP - SÜRGÜLÜ

SLIDING CUPBOARD OVER BASE

Main Code : U055 0263 00 SK



* Option - Kilit ~ Lock

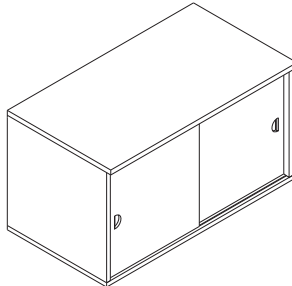

H	D	L	
500	400	600	STN.A
500	400	700	
500	400	900	
500	500	600	
500	500	700	
500	500	900	



ÜÇGE SHOPFITTING & DESIGN

BAZA ÜSTÜ DOLAP - SÜRGÜLÜ CAM

SLIDING CUPBOARD OVER BASE GLASS

Main Code : U055 0263 00 SC



* Option - Kilit - Lock

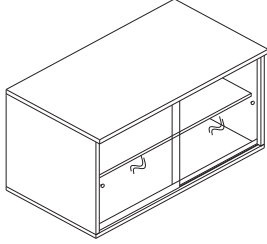

BAZA ÜSTÜ DOLAP - ÇEKMECELİ

CUPBOARD OVER BASE WITH DRAWERS

Main Code : U055 0263 00 CK



* Option - Kilit - Lock

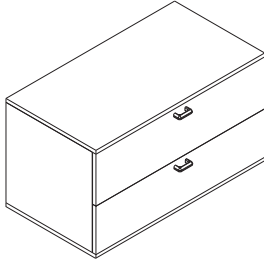

Ölçü Dimension			Renk Color Code
H	D	L	
500	400	600	STN.A
500	400	700	
500	400	900	
500	500	600	
500	500	700	
500	500	900	
H	D	L	
500	400	600	STN.A
500	400	700	
500	400	900	
500	500	600	
500	500	700	
500	500	900	



ÜÇGE SHOPFITTING & DESIGN

BANKO - T0006

SHOWCASE COUNTER - T0006

Main Code : U073 0006 00



* Option - Kilit ~ Lock

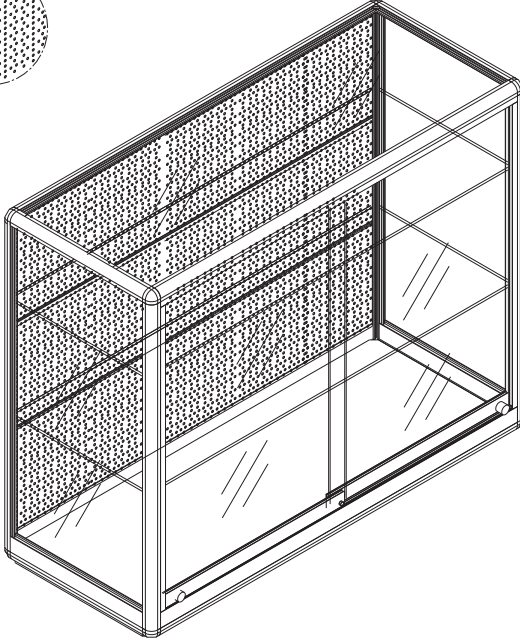
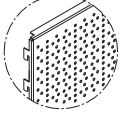

Ölçü Dimension			Renk Color Code
H	D	L	
750	400	700	STN.R
750	400	1000	
750	400	1250	
750	400	1330	
1000	400	700	
1000	400	1000	
1000	400	1250	
1000	400	1330	
1250	400	700	
1250	400	1000	
1250	400	1250	
1250	400	1330	
1500	400	700	
1500	400	1000	
1500	400	1250	
1500	400	1330	
750	500	700	
750	500	1000	
750	500	1250	
750	500	1330	
1000	500	700	
1000	500	1000	
1000	500	1250	
1000	500	1330	
1250	500	700	
1250	500	1000	
1250	500	1250	
1250	500	1330	
1500	500	700	
1500	500	1000	
1500	500	1250	
1500	500	1330	



ÜÇGE SHOPFITTING & DESIGN

BANKO - T0270

SHOWCASE COUNTER - T0270

Main Code : U055 0270 00



* Option - Kilit - Lock

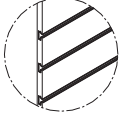

KPG 100mm

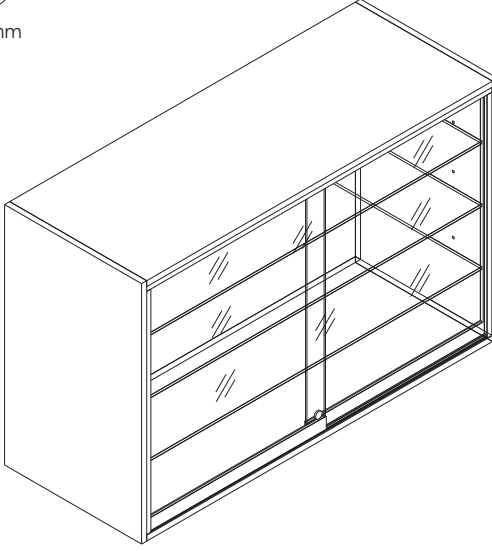

Ölçü Dimension			Renk Color Code
H	D	L	
750	400	600	STN.A
750	400	700	
750	400	900	
1000	400	600	
1000	400	700	
1000	400	900	
1250	400	600	
1250	400	700	
1250	400	900	
1500	400	600	
1500	400	700	
1500	400	900	
750	500	600	
750	500	700	
750	500	900	
1000	500	600	
1000	500	700	
1000	500	900	
1250	500	600	
1250	500	700	
1250	500	900	
1500	500	600	
1500	500	700	
1500	500	900	



PLEKSİ ÜNİTE SEPERATÖR - T0172

ACRYLIC UNIT SEPERATOR - T0172
Main Code : U038 0172 00 GA

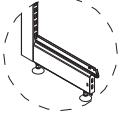

Ölçü Dimension			Renk Color Code	
H	D	L		
1430	400		SYDB	
1640	400			
1850	400			
2060	400			
2270	400			
2480	400			
1430	500			
1640	500			
1850	500			
2060	500			
2270	500			
2480	500			

PLEKSİ ÜNİTE SEPERATÖR - T0172

ACRYLIC UNIT SEPERATOR - T0172
Main Code : U038 0172 00 KA

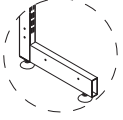

H	D	L		
1430	400		SYDB	
1640	400			
1850	400			
2060	400			
2270	400			
2480	400			
1430	500			
1640	500			
1850	500			
2060	500			
2270	500			
2480	500			

PLEKSİ ÜNİTE SEPERATÖR - T0173

ACRYLIC UNIT SEPERATOR - T0173
Main Code : U038 0173 00 GA

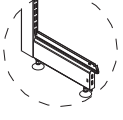

H	D	L		
1430	400		SYDB	
1640	400			
1850	400			
2060	400			
2270	400			
2480	400			
1430	500			
1640	500			
1850	500			
2060	500			
2270	500			
2480	500			

PLEKSİ ÜNİTE SEPERATÖR - T0173

ACRYLIC UNIT SEPERATOR - T0173
Main Code : U038 0173 00 KA

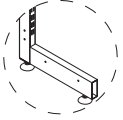

H	D	L		
1430	400		SYDB	
1640	400			
1850	400			
2060	400			
2270	400			
2480	400			
1430	500			
1640	500			
1850	500			
2060	500			
2270	500			
2480	500			



ÜÇGE SHOPFITTING & DESIGN

AHŞAP ÜST KAPAK DÜZ - SUNTALAM

WOODEN TOP COVER CHIPBOARD

Main Code : U063 0006 00 SLM

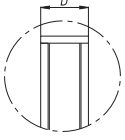

30x60mm ~ 96mm
30x80mm ~ 116mm

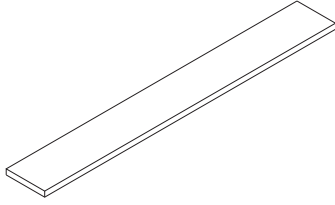

AHŞAP ÜST KAPAK DÜZ - MDFLAM

WOODEN TOP COVER MDFLAM

Main Code : U063 0006 00 MLM

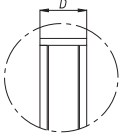

30x60mm ~ 96mm
30x80mm ~ 116mm

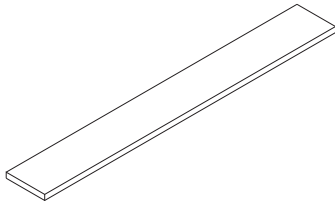

Ölçü Dimension			Renk Color Code
H	D	L	
18	96	600	STN.A
18	96	700	
18	96	900	
18	116	600	
18	116	700	
18	116	900	
SAĞ - RIGHT			
18	96	615	
18	96	715	
18	96	915	
18	116	615	
18	116	715	
18	116	915	
SOL - LEFT			
18	96	615	
18	96	715	
18	96	915	
18	116	615	
18	116	715	
18	116	915	
Tekli - Singles			
18	96	630	
18	96	730	
18	96	930	
18	116	630	
18	116	730	
18	116	930	
H	D	L	STN.A
18	96	600	
18	96	700	
18	96	900	
18	116	600	
18	116	700	
18	116	900	
SAĞ - RIGHT			
18	96	615	
18	96	715	
18	96	915	
18	116	615	
18	116	715	
18	116	915	
SOL - LEFT			
18	96	615	
18	96	715	
18	96	915	
18	116	615	
18	116	715	
18	116	915	
Tekli - Singles			
18	96	630	
18	96	730	
18	96	930	
18	116	630	
18	116	730	
18	116	930	



UCGE SHOPFITTING & DESIGN

AHŞAP YAN KAPAK L - SUNTALAM - DPK

WOODEN SIDE COVER L CHIPBOARD DPK
Main Code : U038 0051 00 SLM.DPK

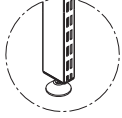

30x60mm



Ölçü Dimension			Renk Color Code
H	D	L	
1010	78	36	STN.A
1220	78	36	
1430	78	36	
1640	78	36	
1850	78	36	
2060	78	36	
2270	78	36	
2480	78	36	

AHŞAP YAN KAPAK L - SUNTALAM - DUK

WOODEN SIDE COVER L CHIPBOARD DUK
Main Code : U038 0051 00 SLM.DUK

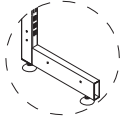

30x60mm



SAĞ - RIGHT			Renk Color Code
H	D	L	
1010	78	36	STN.A
1220	78	36	
1430	78	36	
1640	78	36	
1850	78	36	
2060	78	36	
2270	78	36	
2480	78	36	
SOL - LEFT			
1010	78	36	
1220	78	36	
1430	78	36	
1640	78	36	
1850	78	36	
2060	78	36	
2270	78	36	

AHŞAP YAN KAPAK L - SUNTALAM - DPK

WOODEN SIDE COVER L CHIPBOARD DPK
Main Code : U038 0051 00 SLM.DPK

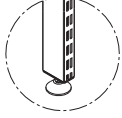

30x80mm



H	D	L	Renk Color Code
1010	98	36	
1220	98	36	
1430	98	36	
1640	98	36	
1850	98	36	
2060	98	36	
2270	98	36	
2480	98	36	

AHŞAP YAN KAPAK L - SUNTALAM - DUK

WOODEN SIDE COVER L CHIPBOARD DUK
Main Code : U038 0051 00 SLM.DUK

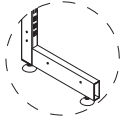

30x80mm



SAĞ - RIGHT			Renk Color Code	
H	D	L		
1640	98	36	STN.A	
1850	98	36		
2060	98	36		
2270	98	36		
2480	98	36		
SOL - LEFT				
1640	98	36		
1850	98	36		
2060	98	36		
2270	98	36		
2480	98	36		



ÜÇGE SHOPFITTING & DESIGN

AHŞAP YAN KAPAK L - MDFLAM - DPK

WOODEN SIDE COVER L MDFLAM DPK
Main Code : U038 0051 00 MLM.DPK

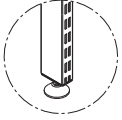

30x60mm



AHŞAP YAN KAPAK L - MDFLAM - DUK

WOODEN SIDE COVER L MDFLAM DUK
Main Code : U038 0051 00 MLM.DUK

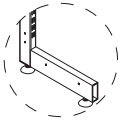

30x60mm



AHŞAP YAN KAPAK L - MDFLAM - DPK

WOODEN SIDE COVER L MDFLAM DPK
Main Code : U038 0051 00 MLM.DPK



30x80mm



AHŞAP YAN KAPAK L - MDFLAM - DUK

WOODEN SIDE COVER L MDFLAM DUK
Main Code : U038 0051 00 MLM.DUK

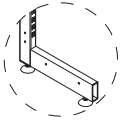

30x80mm



Ölçü Dimension			Renk Color Code
H	D	L	
1010	78	36	STN.A
1220	78	36	
1430	78	36	
1640	78	36	
1850	78	36	
2060	78	36	
2270	78	36	
2480	78	36	
H	D	L	
SAĞ - RIGHT			STN.A
1010	78	36	
1220	78	36	
1430	78	36	
1640	78	36	
1850	78	36	
2060	78	36	
2270	78	36	
2480	78	36	
SOL - LEFT			
1010	78	36	
1220	78	36	
1430	78	36	
1640	78	36	
1850	78	36	
2060	78	36	
2270	78	36	
2480	78	36	
H	D	L	
1010	98	36	STN.A
1220	98	36	
1430	98	36	
1640	98	36	
1850	98	36	
2060	98	36	
2270	98	36	
2480	98	36	
H	D	L	
SAĞ - RIGHT			STN.A
1640	98	36	
1850	98	36	
2060	98	36	
2270	98	36	
2480	98	36	
SOL - LEFT			
1640	98	36	
1850	98	36	
2060	98	36	
2270	98	36	
2480	98	36	



UCGE SHOPFITTING & DESIGN

AHŞAP YAN KAPAK L - SUNTALAM - OUK

WOODEN SIDE COVER L CHIPBOARD OUK

Main Code : U038 0051 00 SLM.OUK

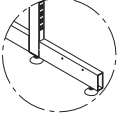

30x60mm



Ölçü Dimension			Renk Color Code
H	D	L	
1010	96	36	STN.A
1220	96	36	
1430	96	36	
1640	96	36	
1850	96	36	
2060	96	36	
2270	96	36	
2480	96	36	
H	D	L	
1010	96	36	STN.A
1220	96	36	
1430	96	36	
1640	96	36	
1850	96	36	
2060	96	36	
2270	96	36	
2480	96	36	
H	D	L	
1640	116	36	STN.A
1850	116	36	
2060	116	36	
2270	116	36	
2480	116	36	
H	D	L	
1640	116	36	STN.A
1850	116	36	
2060	116	36	
2270	116	36	
2480	116	36	

AHŞAP YAN KAPAK L - MDFLAM - OUK

WOODEN SIDE COVER L MDFLAM OUK

Main Code : U038 0051 00 MLM.OUK

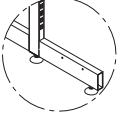

30x60mm



AHŞAP YAN KAPAK L - SUNTALAM - OUK

WOODEN SIDE COVER L CHIPBOARD OUK

Main Code : U038 0051 00 SLM.OUK

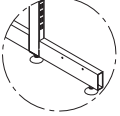

30x80mm



AHŞAP YAN KAPAK L - MDFLAM - OUK

WOODEN SIDE COVER L MDFLAM OUK

Main Code : U038 0051 00 MLM.OUK

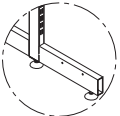

30x80mm





ÜÇGE SHOPFITTING & DESIGN

GONDOL YAN KAPAK - SUNTALAM - T0174

GONDOLA SIDE COVER CHIPBOARD - T0174

Main Code : U038 0174 00 SLM



Ölçü Dimension			Renk Color Code
H	D	L	
1430	150	18	STN.A
1640	150	18	
1850	150	18	
2060	150	18	
2270	150	18	
2480	150	18	
1430	250	18	
1640	250	18	
1850	250	18	
2060	250	18	
2270	250	18	
2480	250	18	
1430	380	18	
1640	380	18	
1850	380	18	
2060	380	18	
2270	380	18	
2480	380	18	
1430	480	18	
1640	480	18	
1850	480	18	
2060	480	18	
2270	480	18	
2480	480	18	
1430	580	18	
1640	580	18	
1850	580	18	
2060	580	18	
2270	580	18	
2480	580	18	



ÜÇGE SHOPFITTING & DESIGN

GONDOL YAN KAPAK - MDFLAM - T0174

GONDOLA SIDE COVER MDFLAM - T0174

Main Code : U038 0174 00 MLM



Ölçü Dimension			Renk Color Code
H	D	L	
1430	150	18	STN.A
1640	150	18	
1850	150	18	
2060	150	18	
2270	150	18	
2480	150	18	
1430	250	18	
1640	250	18	
1850	250	18	
2060	250	18	
2270	250	18	
2480	250	18	
1430	380	18	
1640	380	18	
1850	380	18	
2060	380	18	
2270	380	18	
2480	380	18	
1430	480	18	
1640	480	18	
1850	480	18	
2060	480	18	
2270	480	18	
2480	480	18	
1430	580	18	
1640	580	18	
1850	580	18	
2060	580	18	
2270	580	18	
2480	580	18	



GONDOL YAN KAPAK - MDFLAM - T0169

GONDOLA SIDE COVER MDFLAM - T0169
Main Code : U038 0169 00 MLM

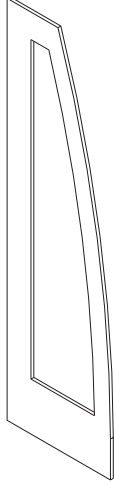

Ölçü Dimension			Renk Color Code
H	D	L	
1430	380	18	STN.A
1430	480	18	
1430	580	18	
1430	680	18	
1640	380	18	
1640	480	18	
1640	580	18	
1640	680	18	
1850	380	18	
1850	480	18	
1850	580	18	
1850	680	18	
2060	380	18	
2060	480	18	
2060	580	18	
2060	680	18	
2270	380	18	
2270	480	18	
2270	580	18	
2270	680	18	
2480	380	18	
2480	480	18	
2480	580	18	
2480	680	18	

GONDOL YAN KAPAK - MDFLAM - T0175

GONDOLA SIDE COVER MDFLAM - T0175
Main Code : U038 0175 00 MLM

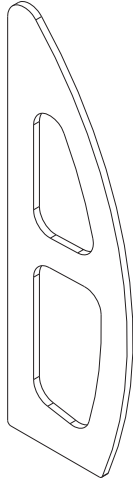

H	D	L	
1430	380	18	STN.A
1430	480	18	
1430	580	18	
1430	680	18	
1640	380	18	
1640	480	18	
1640	580	18	
1640	680	18	
1850	380	18	
1850	480	18	
1850	580	18	
1850	680	18	
2060	380	18	
2060	480	18	
2060	580	18	
2060	680	18	
2270	380	18	
2270	480	18	
2270	580	18	
2270	680	18	
2480	380	18	
2480	480	18	
2480	580	18	
2480	680	18	



UCGE SHOPFITTING & DESIGN

GONDOL YAN KAPAK - T0104

GONDOLA SIDE COVER - T0104

Main Code : U038 0104 00

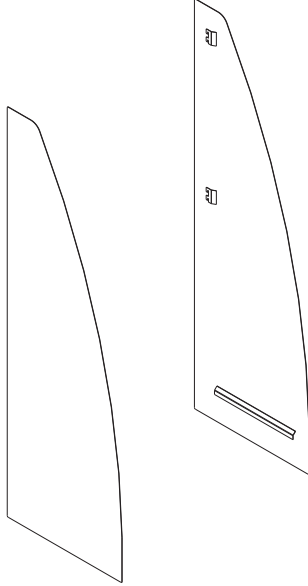

Ölçü Dimension			Renk Color Code
H	D	L	
1430	380	18	STN.R
1430	480	18	
1430	580	18	
1430	680	18	
1640	380	18	
1640	480	18	
1640	580	18	
1640	680	18	
1850	380	18	
1850	480	18	
1850	580	18	
1850	680	18	
2060	380	18	
2060	480	18	
2060	580	18	
2060	680	18	
2270	380	18	
2270	480	18	
2270	580	18	
2270	680	18	
2480	380	18	
2480	480	18	
2480	580	18	
2480	680	18	

ŞAPKA - T0034

CANOPY - T0034

Main Code : U024 0034 00

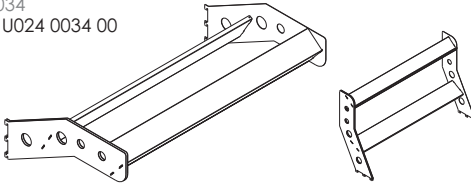

* Aydınlatma dahil. - Lighting included.

H	D	L	
350	600	600	STN.R
350	600	700	
350	600	900	

ŞAPKA - T0033

CANOPY - T0033

Main Code : U024 0033 00

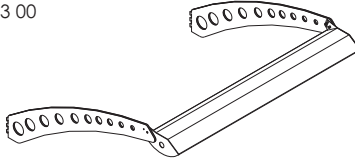

* Aydınlatma dahil. - Lighting included.

H	D	L	
550	1000	600	STN.R
550	1000	700	
550	1000	900	

ŞAPKA - T0032

CANOPY - T0032

Main Code : U024 0032 00

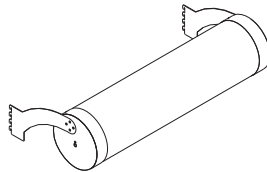

* Aydınlatma dahil. - Lighting included.

H	D	L	
300	500	600	STN.R
300	500	700	
300	500	900	



ŞAPKA - T0005

CANOPY - T0005
Main Code : U024 0005 00

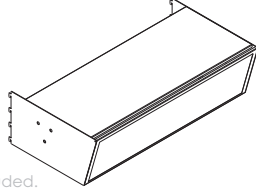

* Aydınlatma dahil. ~ Lighting included.

ŞAPKA - T0036

CANOPY - T0036
Main Code : U024 0036 00

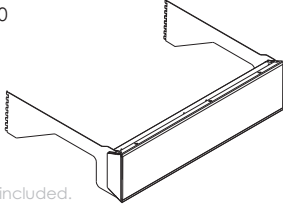

* Aydınlatma dahil. ~ Lighting included.

ŞAPKA - T0037

CANOPY - T0037
Main Code : U024 0037 00

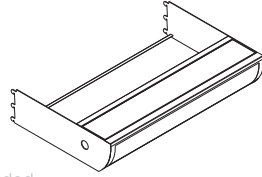

* Aydınlatma dahil. ~ Lighting included.

ŞAPKA - T0044

CANOPY - T0044
Main Code : U025 0044 00

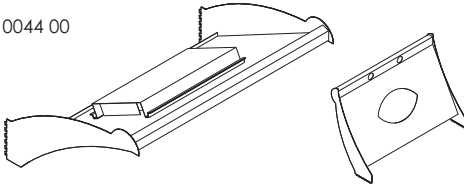

* Aydınlatma dahil. ~ Lighting included.

ŞAPKA - T0047

CANOPY - T0047
Main Code : U024 0047 00

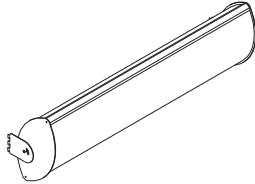

* Aydınlatma dahil. ~ Lighting included.

ŞAPKA - T0048

CANOPY - T0048
Main Code : U024 0048 00

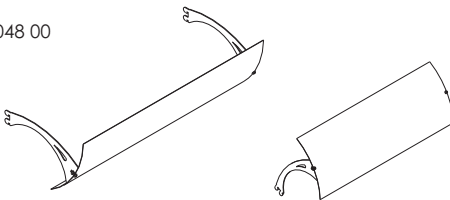

Ölçü Dimension			Renk Color Code
H	D	L	
250	500	600	STN.R
250	500	700	
250	500	900	
			SYDB
H	D	L	
200	400	600	STN.R
200	400	700	
200	400	900	
200	500	600	SYDB
200	500	700	
200	500	900	
200	600	600	STN.R
200	600	700	
200	600	900	
H	D	L	
200	400	600	STN.R
200	400	700	
200	400	900	
200	500	600	SYDB
200	500	700	
200	500	900	
200	600	600	STN.R
200	600	700	
200	600	900	
H	D	L	
550	900	600	STN.R
550	900	700	
550	900	900	
			SYDB
H	D	L	
400	300	600	STN.R
400	300	700	
400	300	900	
			SYDB
H	D	L	
300	400	600	STN.R
300	400	700	
300	400	900	



ÜÇGE SHOPFITTING & DESIGN

ŞAPKA - T0038

CANOPY - T0038
Main Code : U024 0038 00

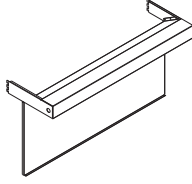

* Aydınlatma dahil. - Lighting included.

ŞAPKA - T0054

CANOPY - T0054
Main Code : U025 0054 00

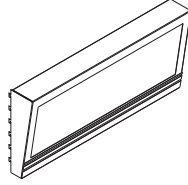

* Aydınlatma dahil. - Lighting included.

ŞAPKA - T0088

CANOPY - T0088
Main Code : U025 0088 00

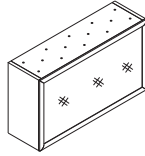

* Aydınlatma dahil. - Lighting included.

Ölçü Dimension			Renk Color Code
H	D	L	
700	450	600	STN.R
700	450	700	
700	450	900	
H	D	L	
455	140	600	STN.R SYDB
455	140	700	
455	140	900	
H	D	L	
300	200	500	STN.R SYDB
400	200	700	



ÜST KAPAK - T0078

TOP COVER - T0078
Main Code : U024 0078 00

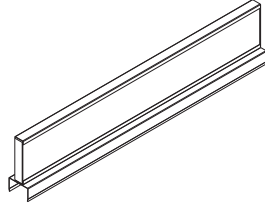
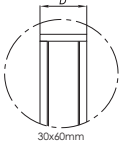

ÜST KAPAK - T0028

TOP COVER - T0028
Main Code : U024 0028 00

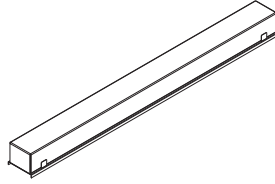
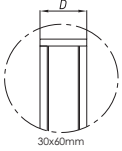

* Aydınlatma dahil. - Lighting included.

ÜST KAPAK - T0021

TOP COVER - T0021
Main Code : U025 0021 00

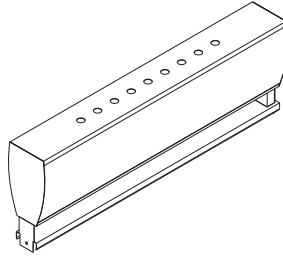
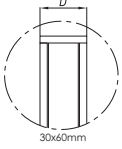

* Aydınlatma dahil. - Lighting included.

Ölçü Dimension			Renk Color Code
H	D	L	
210	100	600	
210	100	700	
210	100	900	
Bitim & End			
210	100	615	STN.R
210	100	715	
210	100	915	SYDB
Tekli - Singles			
210	100	630	
210	100	730	
210	100	930	
H	D	L	
70	100	600	
70	100	700	
70	100	900	
Bitim & End			
70	100	615	STN.R
70	100	715	
70	100	915	SYDB
Tekli - Singles			
70	100	630	
70	100	730	
70	100	930	
H	D	L	
350	100	600	
350	100	700	
350	100	900	
Bitim & End			
350	100	615	STN.R
350	100	715	
350	100	915	SYDB
Tekli - Singles			
350	100	630	
350	100	730	
350	100	930	



GIDA HARICI ÜNİTELER

Non Food Units

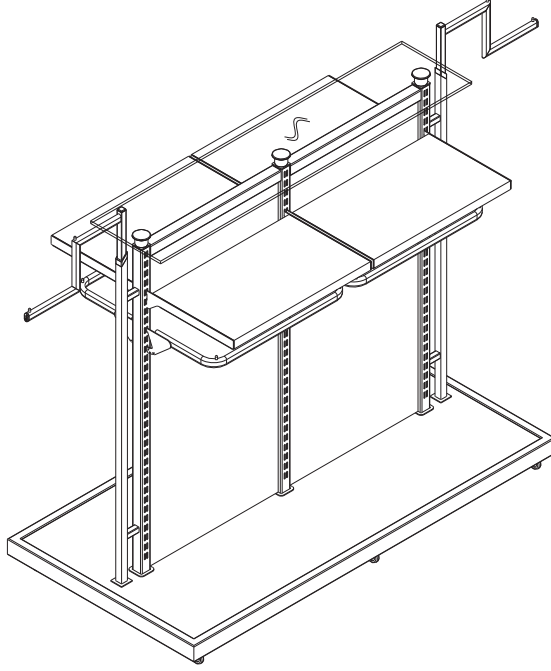

GIDA HARİCİ ORTA ÜNİTE - T0267

NON FOOD GONDOLA - T0267
Main Code : U049 0267 00 G1

* Option - Tekerlekli
~ With wheels

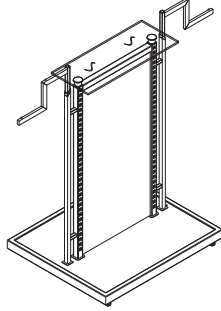

H	D	L	
1640	800	600	
1640	800	700	
1640	800	900	
			STN.R
			STN.A

GIDA HARİCİ ORTA ÜNİTE - T0267

NON FOOD GONDOLA - T0267
Main Code : U049 0267 00 G2

* Option - Tekerlekli
~ With wheels

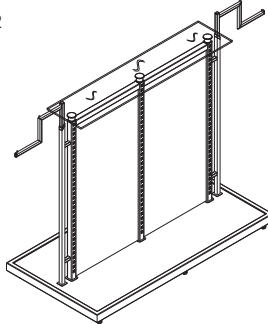

H	D	L	
1640	800	1200	
1640	800	1400	
1640	800	1800	
			STN.R
			STN.A

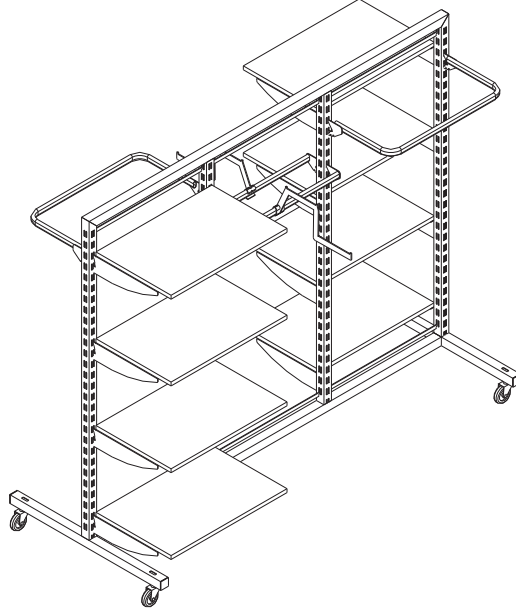

GIDA HARİCİ ORTA ÜNİTE - T0265

NON FOOD GONDOLA - T0265

Main Code : U049 0265 00 G1

* Option - Tekerlekli
- With wheels

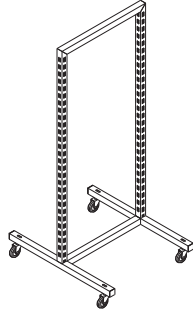

H	D	L	
1640	800	600	STN.R
1640	800	700	
1640	800	900	

GIDA HARİCİ ORTA ÜNİTE - T0265

NON FOOD GONDOLA - T0265

Main Code : U049 0265 00 G2

* Option - Tekerlekli
- With wheels

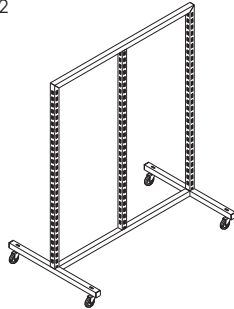

H	D	L	
1640	800	1200	STN.R
1640	800	1400	
1640	800	1800	



UCGE SHOPFITTING & DESIGN

GIDA HARİCİ ORTA ÜNİTE - T0265

NON FOOD GONDOLA - T0265
Main Code : U049 0265 00 G3

* Option - Tekerlekli
~ With wheels

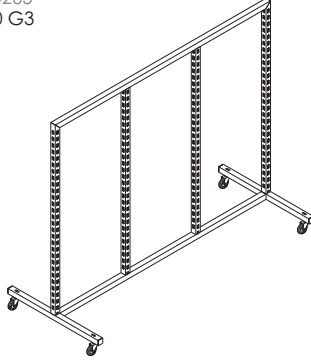

Ölçü Dimension			Renk Color Code
H	D	L	
1640	800	1800	STN.R
1640	800	2100	

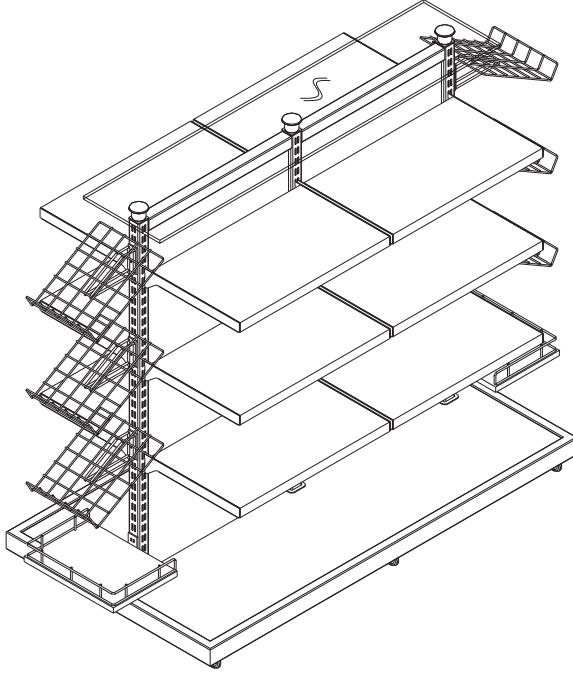

GIDA HARİCİ ORTA ÜNİTE - T0268

NON FOOD GONDOLA - T0268

Main Code : U049 0268 00 G1

* Option - Tekerlekli
- With wheels

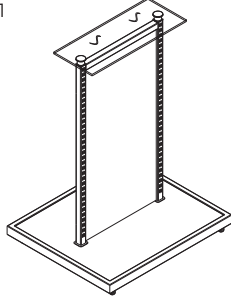

H	D	L	
1640	800	600	
1640	800	700	STN.R
1640	800	900	STN.A

GIDA HARİCİ ORTA ÜNİTE - T0268

NON FOOD GONDOLA - T0268

Main Code : U049 0268 00 G2

* Option - Tekerlekli
- With wheels

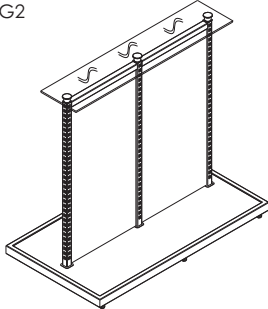

H	D	L	
1640	800	1200	
1640	800	1400	STN.R
1640	800	1800	STN.A



ÜÇGE SHOPFITTING & DESIGN

GIDA HARİCİ ORTA ÜNİTE - T0288 - AR

NON FOOD GONDOLA - T0288 - AR
Main Code : U049 0268 10

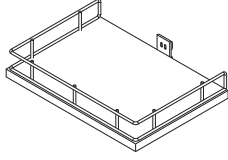

GIDA HARİCİ ORTA ÜNİTE - T0288 - TR

NON FOOD GONDOLA - T0288 - TR
Main Code : U049 0268 20

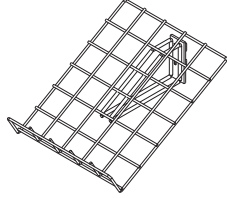

Ölçü Dimension			Renk Color Code
H	D	L	
60	250	350	STN.A NKL
H	D	L	
60	300	250	NKL

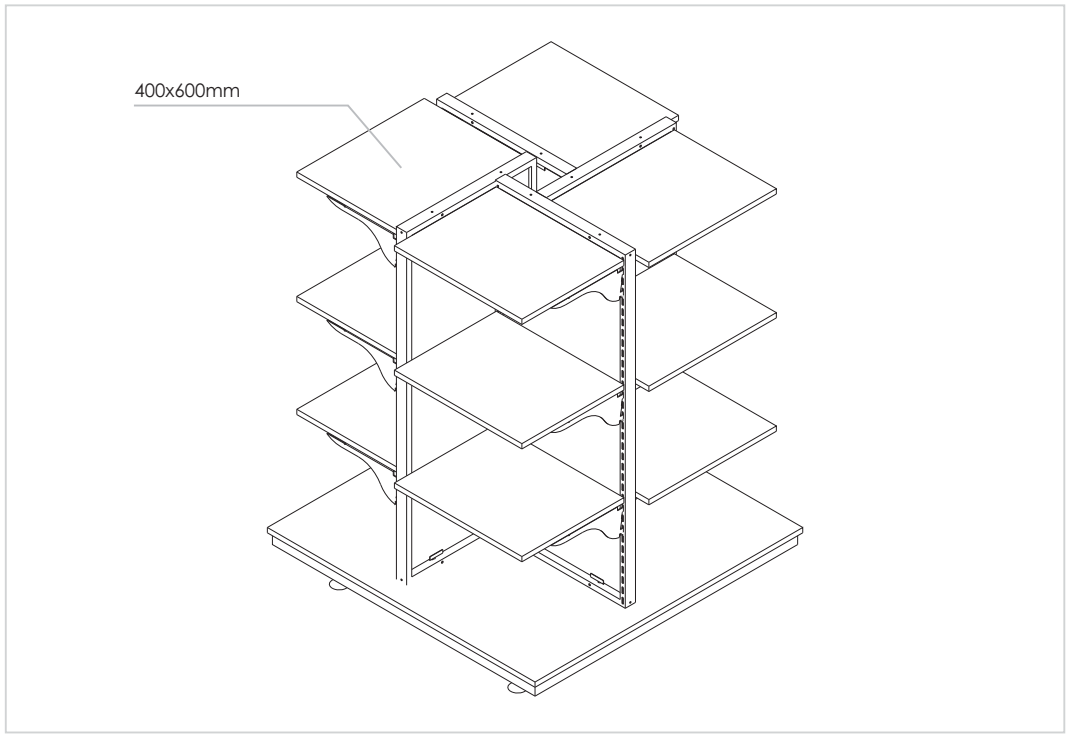

GIDA HARİCİ ORTA ÜNİTE - T0269

NON FOOD GONDOLA - T0269

Main Code : U049 0269 00

* Option - Tekerlekli

 - With wheels

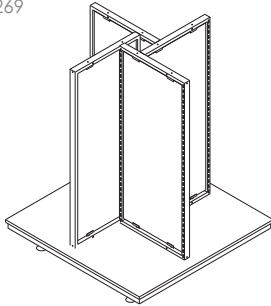

H	D	L	
1640	1200	1200	STN.R STN.A



UCGE SHOPFITTING & DESIGN

GIDA HARİCİ ORTA ÜNİTE - T0270

NON FOOD GONDOLA - T0270
Main Code : U049 0270 00

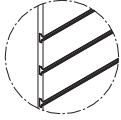

KPG 100mm

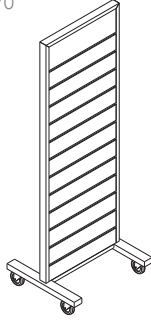

Ölçü Dimension			Renk Color Code
H	D	L	
1220	600	600	STN.R STN.A
1220	600	700	
1220	600	900	
1430	600	600	
1430	600	700	
1430	600	900	
1640	600	600	
1640	600	700	
1640	600	900	

GIDA HARİCİ ORTA ÜNİTE - T0184

NON FOOD GONDOLA - T0184
Main Code : U049 0184 00

* Option - Tekerlekli
~ With wheels

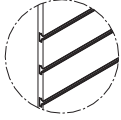

KPG 100mm

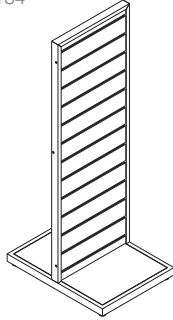

H	D	L	
1220	800	600	STN.R STN.A
1220	800	700	
1220	800	900	
1430	800	600	
1430	800	700	
1430	800	900	
1640	800	600	
1640	800	700	
1640	800	900	

GIDA HARİCİ ORTA ÜNİTE - T0206

NON FOOD GONDOLA - T0206
Main Code : U049 0206 00

* Option - Tekerlekli
~ With wheels



KPG 100mm

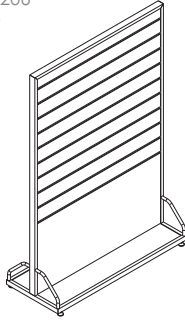

H	D	L	
1430	600	600	STN.R STN.A
1430	600	700	
1430	600	900	
1640	600	600	
1640	600	700	
1640	600	900	

GIDA HARİCİ ORTA ÜNİTE - T0012

NON FOOD GONDOLA - T0012
Main Code : U049 0012 00

* Option - Tekerlekli
~ With wheels



KPG 100mm

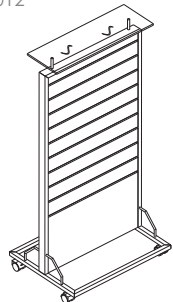

H	D	L	
1430	600	600	STN.R STN.A
1430	600	700	
1430	600	900	
1640	600	600	
1640	600	700	
1640	600	900	



GIDA HARİCİ ORTA ÜNİTE - T0271

NON FOOD GONDOLA - T0271
Main Code : U049 0271 00

* Option - Tekerlekli
- With wheels

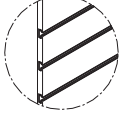

KPG 100mm

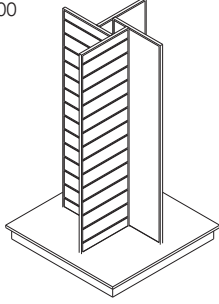

Ölçü Dimension			Renk Color Code
H	D	L	
1430	800	800	STN.A
1430	1000	1000	
1430	1200	1200	
1640	800	800	
1640	1000	1000	
1640	1200	1200	
H	D	L	
1500	600	600	STN.A
H	D	L	
1400	500	1450	STN.R STN.A
H	D	L	
1640	800	1700	STN.R STN.A
1850	800	1700	

GIDA HARİCİ ORTA ÜNİTE - T0141

NON FOOD GONDOLA - T0141
Main Code : U049 0141 00

* Option - Tekerlekli
- With wheels

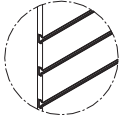

KPG 100mm

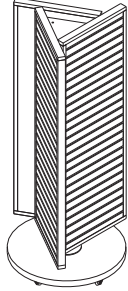

GIDA HARİCİ ORTA ÜNİTE - T0142

NON FOOD GONDOLA - T0142
Main Code : U049 0142 00

* Option - Tekerlekli
- With wheels

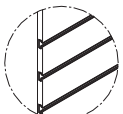

KPG 100mm

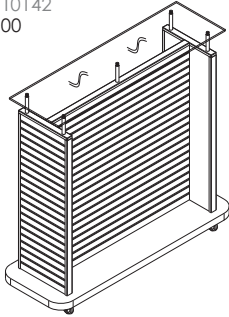

GIDA HARİCİ ORTA ÜNİTE - T0177

NON FOOD GONDOLA - T0177
Main Code : U049 0177 00

* Option - Tekerlekli
- With wheels

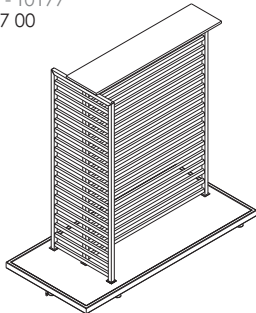
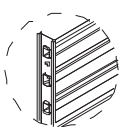



GIDA HARİCİ AKROBATLAR
Non Food Acrobats



UCGE SHOPFITTING & DESIGN

AKROBAT - T0010 AG

ACROBAT - T0010 AG

Main Code : U012 0010 01 AG

* Option - Tekerlekli
- With wheels

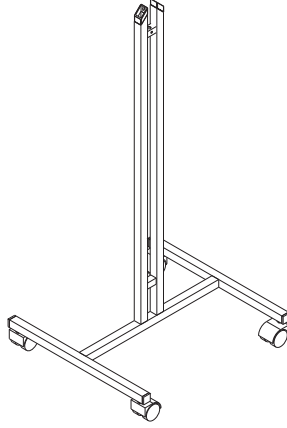

Ölçü Dimension			Renk Color Code
H	D	L	
1000	500	500	STN.R
H	D	L	
1000	500	500	STN.R
H	D	L	
1000	600	600	STN.R STN.A

AKROBAT - T0009 AG

ACROBAT - T0009 AG

Main Code : U012 0009 00 AG

* Option - Tekerlekli
- With wheels

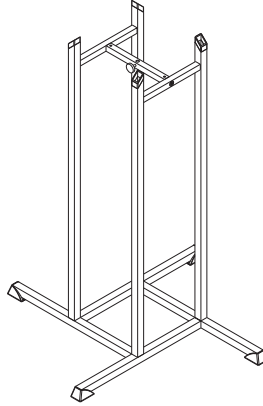
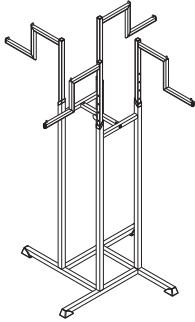

AKROBAT - T0029 AG

ACROBAT - T0029 AG

Main Code : U012 0029 00 AG

* Option - Tekerlekli
- With wheels

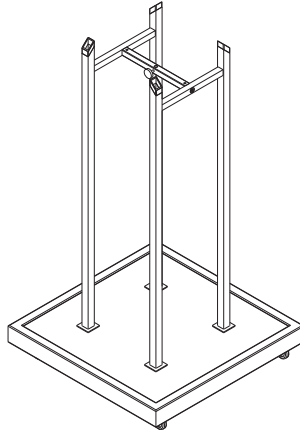
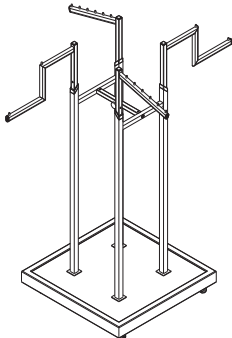



AKROBAT - T0009 AK2

ACROBAT - T0009 AK2
Main Code : U012 0009 02 AK2

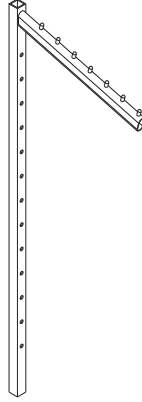
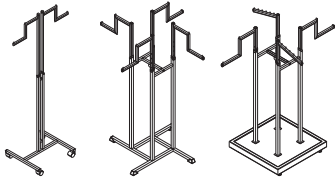

Ölçü Dimension			Renk Color Code
H	D	L	
800	300		NKL
H	D	L	
800	400		NKL
H	D	L	
800	300		NKL

AKROBAT - T0009 AK3

ACROBAT - T0009 AK3
Main Code : U012 0009 03 AK3

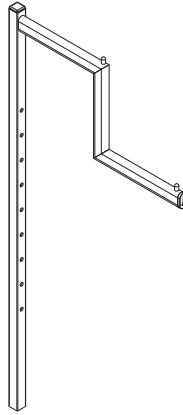
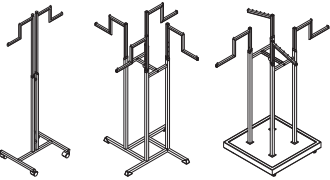

AKROBAT - T0009 AK4

ACROBAT - T0009 AK4
Main Code : U012 0009 04 AK4

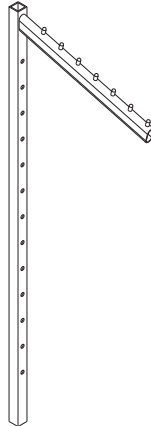
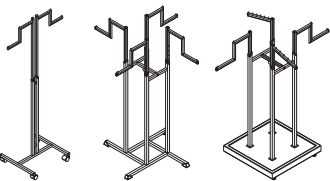



ÜÇGE SHOPFITTING & DESIGN

AKROBAT - T0001

ACROBAT - T0001

Main Code : U012 0001 00

* Option - Tekerlekli

 - With wheels

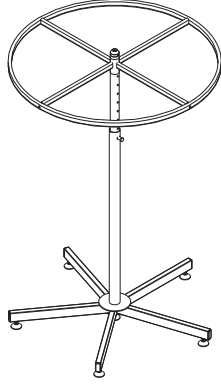

Ölçü Dimension			Renk Color Code
H	D	L	
1500	1000	1000	STN.R NKL
H	D	L	
1300	1000	1000	STN.R NK
H	D	L	
1450	1000	1000	STN.R NK

AKROBAT - T0003

ACROBAT - T0003

Main Code : U012 0003 00

* Option - Tekerlekli

 - With wheels

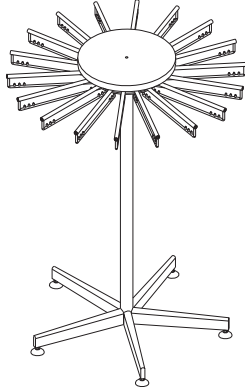

AKROBAT - T0002

ACROBAT - T0002

Main Code : U012 0002 00

* Option - Tekerlekli

 - With wheels

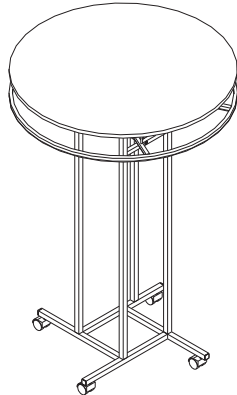



ÜÇGE SHOPFITTING & DESIGN

AKROBAT - T0042

ACROBAT - T0042
Main Code : U049 0042 00

* Option - Tekerekli
- With wheels

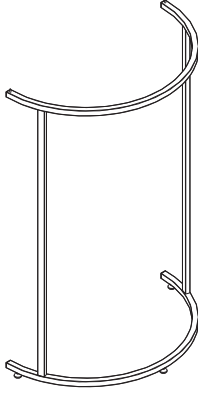

Ölçü
Dimension

Renk
Color Code

H D L
1350 500 1000

PSMZ

AKROBAT - T0007 - ŞEMSIYE TEŞHİR

ACROBAT - T0007 - UMBRELLA DISPLAY
Main Code : U036 0007 00

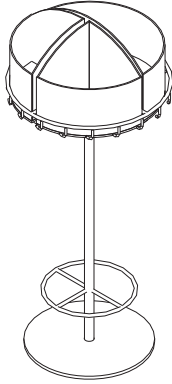

H D L
700 400 400

STN.R

AKROBAT - T0005

ACROBAT - T0005
Main Code : U012 0005 00

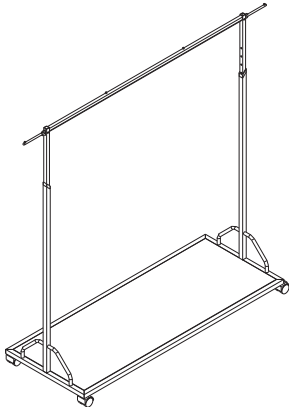

H D L
1200 550 1400

STN.R
NKL



UCGE SHOPFITTING & DESIGN

AKROBAT - T0006

ACROBAT - T0006
Main Code : U012 0006 00

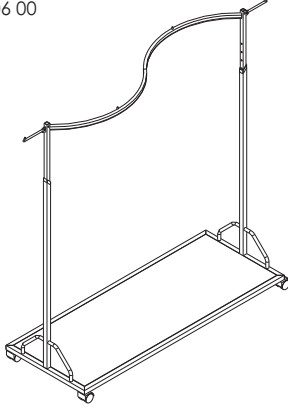

Ölçü Dimension			Renk Color Code
H	D	L	
1200	550	1400	STN.R NKL
H	D	L	
1200	550	1400	STN.R NK
H	D	L	
1550	550	1500	STN.R NK

AKROBAT - T0004

ACROBAT - T0004
Main Code : U012 0004 00

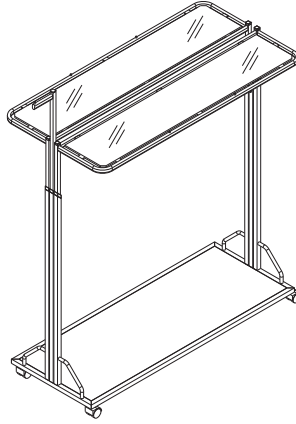

AKROBAT - T0007

ACROBAT - T0007
Main Code : U012 0007 01

* Option - Tekerekli
~ With wheels

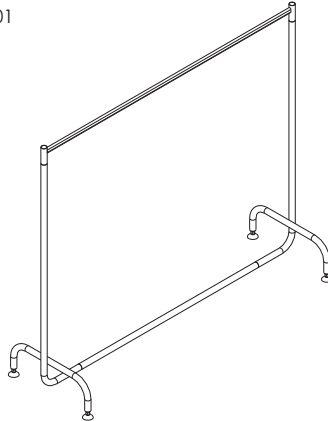



ÜÇGE SHOPFITTING & DESIGN

AKROBAT - T0053

ACROBAT - T0053
Main Code : U012 0053 00

* Option - Tekerlekli
- With wheels

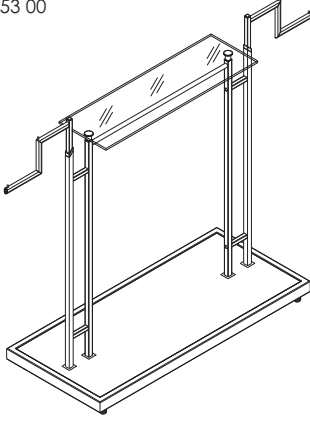

AKROBAT - T0028

ACROBAT - T0028
Main Code : U012 0028 00

* Option - Tekerlekli
- With wheels

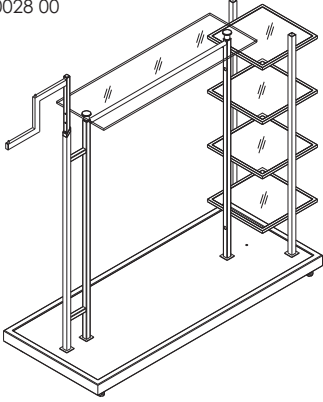

Ölçü Dimension			Renk Color Code
H	D	L	
1200	600	1350	STN.R NKL
H	D	L	
1200	600	1450	STN.R NKL



GIDA HARİCİ ORTA STANDLAR
Non Food Gondolas



ÜÇGE SHOPFITTING & DESIGN

GIDA HARİCİ ORTA STAND - T0139

NON FOOD GONDOLA - T0139
Main Code : U049 0139 00

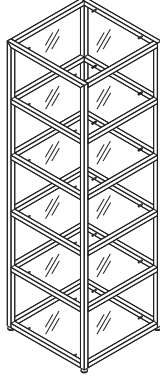

Ölçü Dimension			Renk Color Code
H	D	L	
655	500	500	PSMZ
2 RAFLI WITH 2 SHELVES			
970	500	500	
3 RAFLI WITH 3 SHELVES			
1285	500	500	
4 RAFLI WITH 4 SHELVES			
1600	500	500	
5 RAFLI WITH 5 SHELVES			

GIDA HARİCİ ORTA STAND - T0189

NON FOOD GONDOLA - T0189
Main Code : U049 0189 00

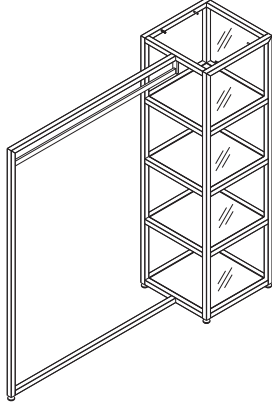

H	D	L	
1500	400	1400	PSMZ

GIDA HARİCİ ORTA STAND - T0187

NON FOOD GONDOLA - T0187
Main Code : U049 0187 00

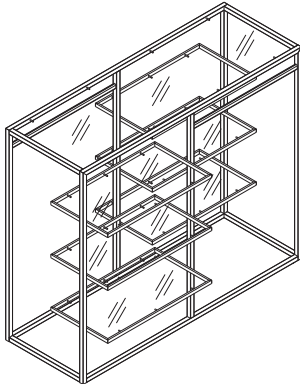

H	D	L	
1300	850	1550	PSMZ



ÜÇGE SHOPFITTING & DESIGN

GIDA HARİCİ ORTA STAND - T0098

NON FOOD GONDOLA - T0098

Main Code : U049 0098 00

* Option - Tekerlekli
- With wheels

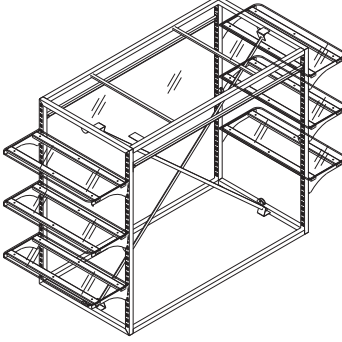

GIDA HARİCİ ORTA STAND - T0155

NON FOOD GONDOLA - T0155

Main Code : U049 0155 00

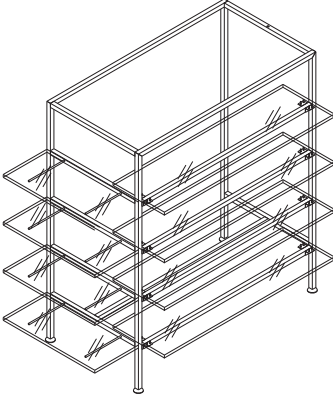

GIDA HARİCİ ORTA STAND - T0176 - GÖVDE

NON FOOD GONDOLA - T0176 - BG

Main Code : U049 0176 00 BG

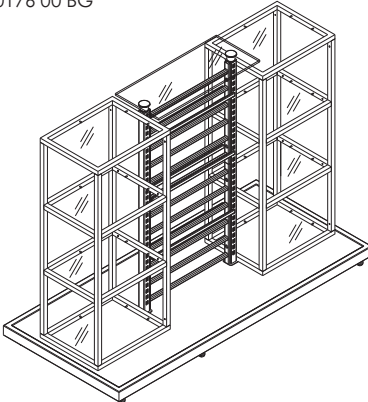

Ölçü
Dimension

Renk
Color Code

H D L
1250 705 1400

PSMZ

H D L
1470 810 1570

PSMZ

H D L
1360 800 1750

NKL



UCGE SHOPFITTING & DESIGN

GIDA HARİCİ ORTA STAND - T0176 - CAM RAF TK

NON FOOD GONDOLA - T0176 - GLASS SHELF SET
Main Code : U041 0098 00

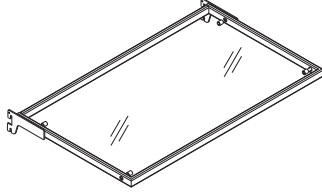

Ölçü Dimension			Renk Color Code
H	D	L	
	300 400	600 600	NKL SYDM

GIDA HARİCİ ORTA STAND - T0004

NON FOOD GONDOLA - T0004
Main Code : U050 0004 00

* Option - Tekerlekli
~ With wheels

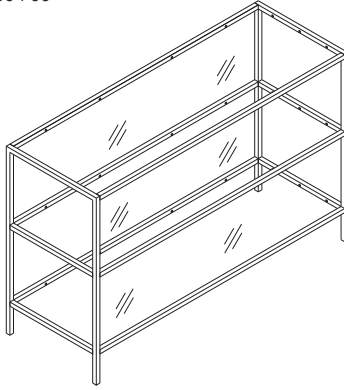

H	D	L	
965	500	1400	PSMZ

GIDA HARİCİ ORTA STAND - T0053

NON FOOD GONDOLA - T0053
Main Code : U050 0053 00

* Option - Tekerlekli
~ With wheels

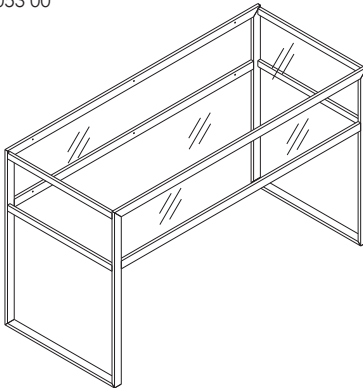

H	D	L	
900	650	1500	PSMZ



ÜÇGE SHOPFITTING & DESIGN

GIDA HARİCİ ORTA STAND - T0115

NON FOOD GONDOLA - T0115

Main Code : U067 0115 00

* Option - Tekerlekli
- With wheels

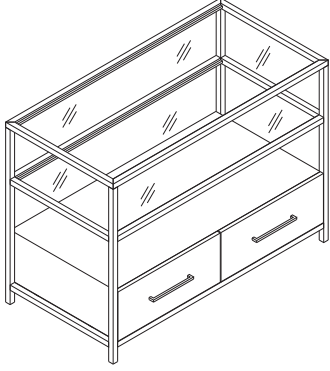

GIDA HARİCİ ORTA STAND - T0072

NON FOOD GONDOLA - T0072

Main Code : U050 0072 00

* Option - Tekerlekli
- With wheels

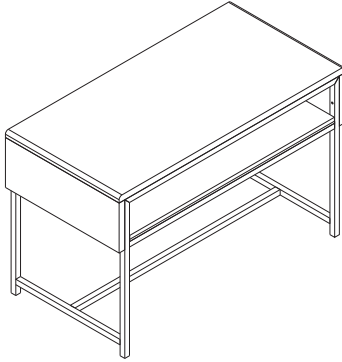

GIDA HARİCİ ORTA STAND - T0037

NON FOOD GONDOLA - T0037

Main Code : U050 0037 00

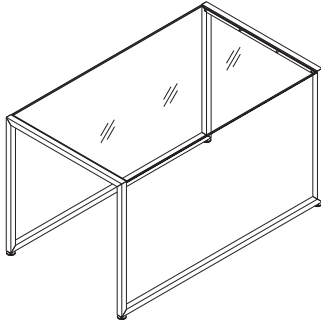
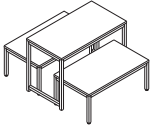

Ölçü Dimension			Renk Color Code
H	D	L	
900	600	1200	PSMZ STN.A
760	600	1200	PSMZ STN.A
550 650 750	750 750 750	1000 1200 1400	PSMZ



ÜÇGE SHOPFITTING & DESIGN

GIDA HARİCİ ORTA STAND - T0009

NON FOOD GONDOLA - T0009

Main Code : U046 0009 00

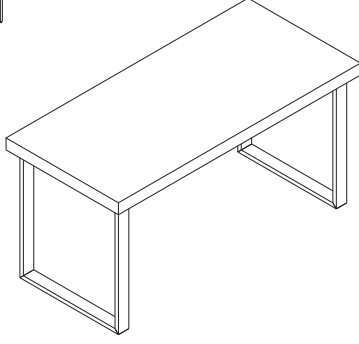
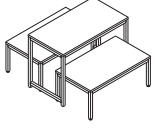

Ölçü Dimension			Renk Color Code
H	D	L	
500	650	1000	PSMZ STN.A
600	650	1200	
700	650	1400	



ÜÇGE SHOPFITTING & DESIGN

GIDA HARİCİ ORTA STAND - T1208

NON FOOD GONDOLA - T1208

Main Code : U012 0008 00

* Option - Tekerlekli
- With wheels

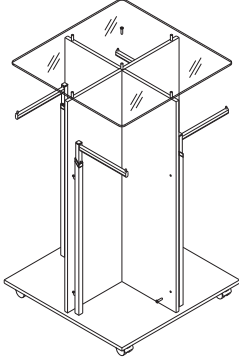

GIDA HARİCİ ORTA STAND - T4908

NON FOOD GONDOLA - T4908

Main Code : U049 0008 00

* Option - Tekerlekli
- With wheels

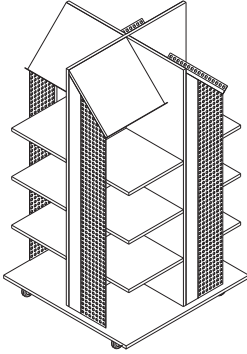

GIDA HARİCİ ORTA STAND - T0011

NON FOOD GONDOLA - T0011

Main Code : U012 0011 00

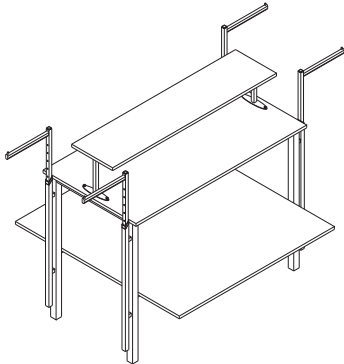

Ölçü Dimension			Renk Color Code
H	D	L	
1300	760	760	STN.A NKL
H	D	L	
1350	760	760	STN.A NKL
H	D	L	
1160	1200	1250	STN.A NK



ÜÇGE SHOPFITTING & DESIGN

GIDA HARİCİ ORTA STAND - T0012

NON FOOD GONDOLA - T0012
Main Code : U012 0012 00

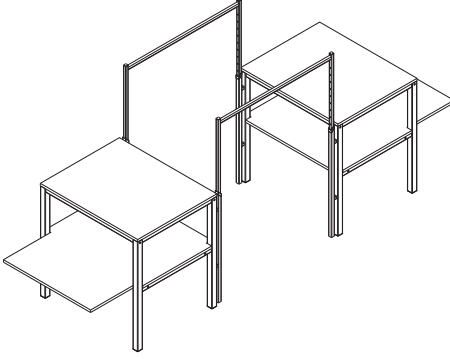

Ölçü Dimension			Renk Color Code
H	D	L	STN.A NKL
1300	800	2295	
H	D	L	STN.A NKL
1500	800	1400	
H	D	L	STN.A NKL
1385	1000	1300	

GIDA HARİCİ ORTA STAND - T0001

NON FOOD GONDOLA - T0001
Main Code : U051 0001 00

* Option - Tekerlekli
~ With wheels

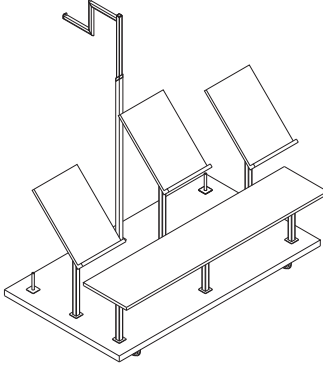

GIDA HARİCİ ORTA STAND - T0063

NON FOOD GONDOLA - T0063
Main Code : U049 0063 00

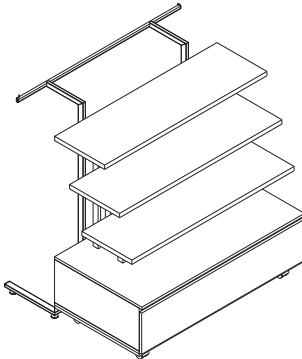



ÜÇGE SHOPFITTING & DESIGN

GIDA HARİCİ ORTA STAND - T0202

NON FOOD GONDOLA - T0202

Main Code : U049 0202 00

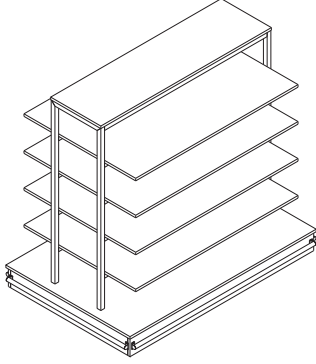

Ölçü
Dimension

Renk
Color Code

H D L
1450 1000 1500

STN.A
STN.R

GIDA HARİCİ ORTA STAND - T0049

NON FOOD GONDOLA - T0049

Main Code : U050 0049 00

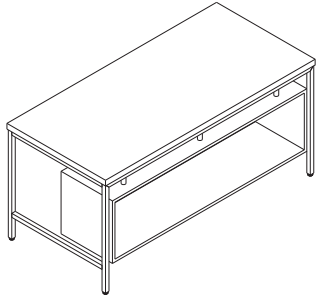

H D L
750 700 1500

STN.A
STN.R

GIDA HARİCİ ORTA STAND - T0051

NON FOOD GONDOLA - T0051

Main Code : U050 0051 00

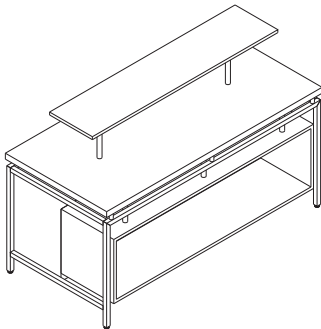

H D L
1300 1000 1500

STN.A
STN.R



ÜÇGE SHOPFITTING & DESIGN

GIDA HARİCİ ORTA STAND - T0203

NON FOOD GONDOLA - T0203
Main Code : U049 0203 00

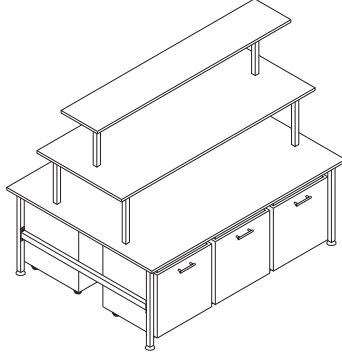

Ölçü Dimension			Renk Color Code
H	D	L	
1400	1200	1600	STN.A STN.R
H	D	L	
895	800	1600	STN.A STN.R
H	D	L	
500 600 700 800	600 600 600 600	800 1000 1200 1400	STN.A STN.R

GIDA HARİCİ ORTA STAND - T0040

NON FOOD GONDOLA - T0040
Main Code : U050 0040 00

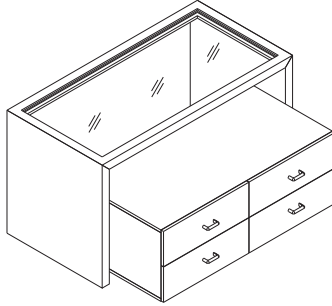

GIDA HARİCİ ORTA STAND - T0001

NON FOOD GONDOLA - T0001
Main Code : U046 0001 00

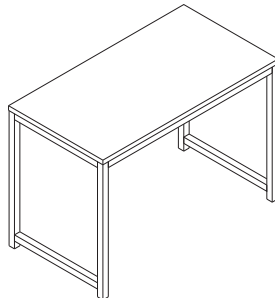
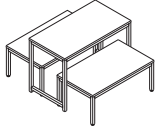



ÜÇGE SHOPFITTING & DESIGN

GIDA HARİCİ ORTA STAND - T0037

NON FOOD GONDOLA - T0037

Main Code : U050 0037 00

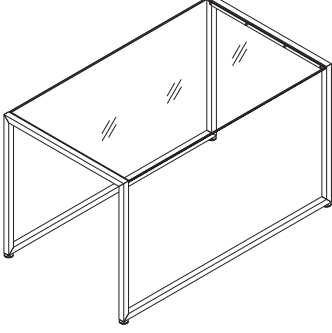
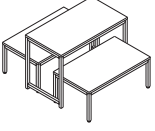

GIDA HARİCİ ORTA STAND - T0009

NON FOOD GONDOLA - T0009

Main Code : U046 0009 00

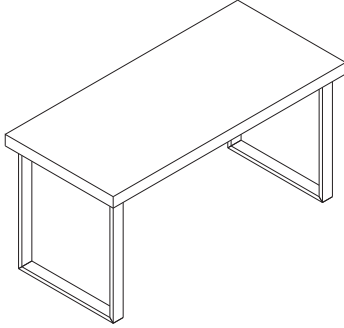
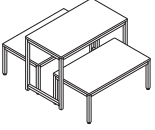

Ölçü Dimension			Renk Color Code
H	D	L	
550	750	1000	
650	750	1200	
750	750	1300	
			STN.A SYD
H	D	L	
500	650	1000	
600	650	1200	
700	650	1400	
			STN.A STN.R



SOYUNMA KABİNİ
AYNALAR-PUFLAR

Fitting Cabinets
& Mirror & Seat Groups



ÜÇGE SHOPFITTING & DESIGN

SOYUNMA KABİNİ - T0002

FITTING CABINET - T0028
Main Code : U054 0002 00

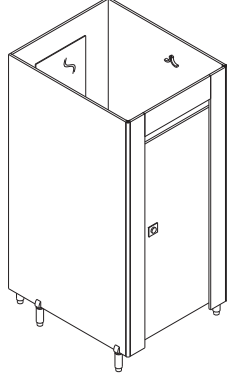

Ölçü Dimension			Renk Color Code	
H	D	L		
2270	1000	1000	STN.A	
2270	1200	1200		
2480	1000	1000		
2480	1200	1200		
2690	1000	1000		
2690	1200	1200		
H	D	L		STN.A
2270	1250	1250		
2480	1250	1250		
2690	1250	1250		
H	D	L	STN.A	
2270	1000	1000		
2270	1200	1200		
2480	1000	1000		
2480	1200	1200		
2690	1000	1000		
2690	1200	1200		

SOYUNMA KABİNİ - T0028

FITTING CABINET - T0028
Main Code : U054 0028 00

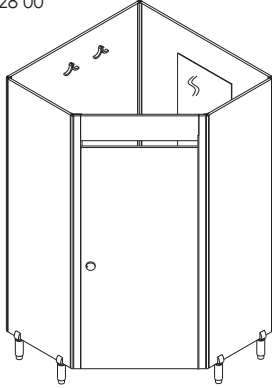

SOYUNMA KABİNİ - T0004

FITTING CABINET - T0004
Main Code : U054 0004 00 1K

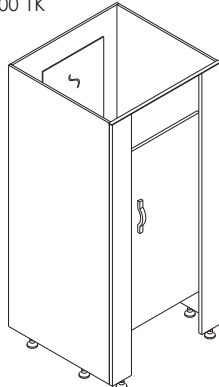



ÜÇGE SHOPFITTING & DESIGN

SOYUNMA KABİNİ - T0004

FITTING CABINET - T0004
Main Code : U054 0004 00 2K

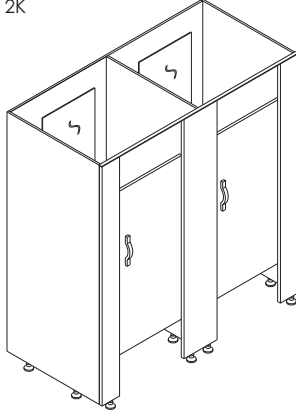

Ölçü Dimension			Renk Color Code
H	D	L	
2270	1000	2000	STN.A
2270	1200	2400	
2480	1000	2000	
2480	1200	2400	
2690	1000	2000	
2690	1200	2400	

H	D	L	
2270	1000	3000	STN.A
2270	1200	3600	
2480	1000	3000	
2480	1200	3600	
2690	1000	3000	
2690	1200	3600	

H	D	L	
2270	1000	4000	STN.A
2270	1200	4800	
2480	1000	4000	
2480	1200	4800	
2690	1000	4000	
2690	1200	4800	

SOYUNMA KABİNİ - T0004

FITTING CABINET - T0004
Main Code : U054 0004 00 3K

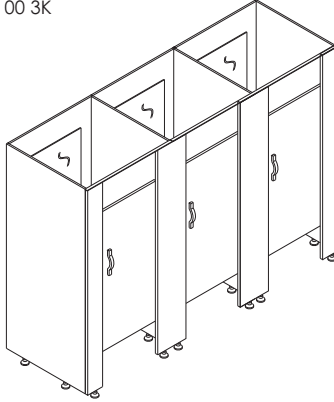

SOYUNMA KABİNİ - T0004

FITTING CABINET - T0004
Main Code : U054 0004 00 4K

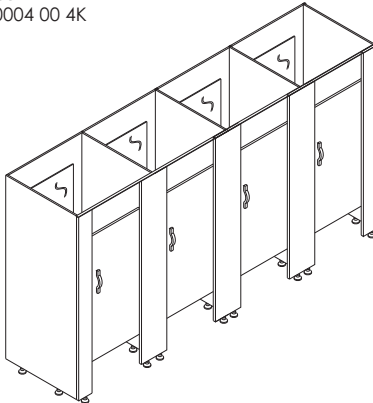



ÜÇGE SHOPFITTING & DESIGN

SOYUNMA KABİNİ - T0041

FITTING CABINET - T0041
Main Code : U054 0041 00

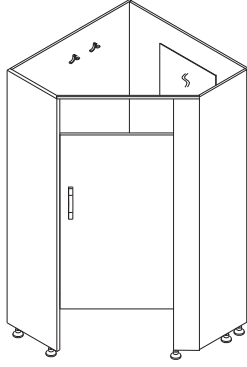

Ölçü Dimension			Renk Color Code
H	D	L	STN.A
2270	1250	1250	
2480	1250	1250	
2690	1250	1250	
H	D	L	STN.A
2270	1000	1000	
2270	1200	1200	
H	D	L	STN.A
2270	1000	1000	
2270	1200	1200	

SOYUNMA KABİNİ - T0014

FITTING CABINET - T0014
Main Code : U054 0014 00

* Option - Tekerlekli
~ With wheels

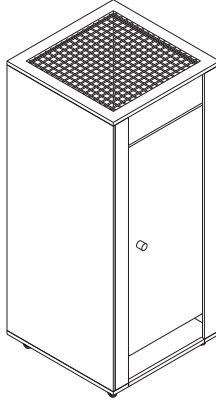

SOYUNMA KABİNİ - T0046

FITTING CABINET - T0046
Main Code : U054 0046 00 1K

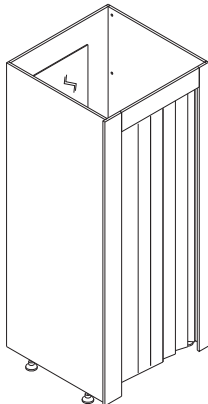



SOYUNMA KABİNİ - T0046

FITTING CABINET - T0046
Main Code : U054 0046 00 2K

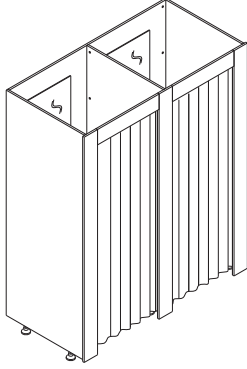

Ölçü
Dimension

Renk
Color Code

H	D	L
2270	1000	2000
2270	1200	2400
2480	1000	2000
2480	1200	2400
2690	1000	2000
2690	1200	2400

STN.A

SOYUNMA KABİN PERDE BORUSU - T0043

FITTING CABINET CURTAIN HANGER TUBE - T0043
Main Code : U054 0043 00



H	D	L
	1200	1200

STN.R

SOYUNMA KABİN PERDE BORUSU - T0044

FITTING CABINET CURTAIN HANGER TUBE - T0044
Main Code : U054 0044 00



H	D	L
	1200	1200

STN.R

SOYUNMA KABİN PERDE BORUSU - T0045

FITTING CABINET CURTAIN HANGER TUBE - T0045
Main Code : U054 0045 00

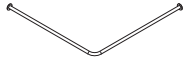

H	D	L
	1200	1200

STN.R



ÜÇGE SHOPFITTING & DESIGN

SOYUNMA KABİNİ - PERDESİ

FITTING CABINET CURTAIN
Main Code : S04 99 002

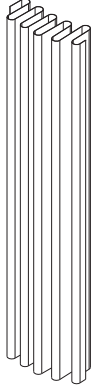

Ölçü Dimension			Renk Color Code
H	D	L	
2250	-	4500	
2450	-	4500	
2250	-	3000	
2450	-	3000	

SOYUNMA KABİNİ - T0003

FITTING CABINET - T0003
Main Code : U054 0003 00

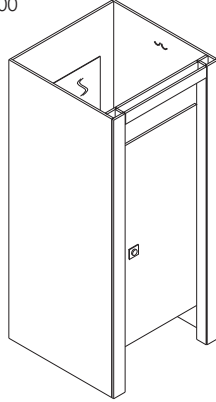

H	D	L	
2270	1000	1000	
2270	1200	1200	
2480	1000	1000	
2480	1200	1200	
2690	1000	1000	
2690	1200	1200	STN.A

OTURMA GRUBU - T0003

SEAT GROUP - T0003
Main Code : U048 0003 00

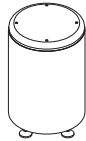

H	D	L	
450	300	300	STN.A

OTURMA GRUBU - T0002

SEAT GROUP - T0002
Main Code : U048 0002 00 2K

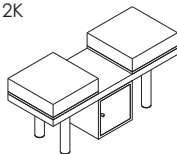

H	D	L	
450	400	1100	STN.A



OTURMA GRUBU - T0002

SEAT GROUP - T0002
Main Code : U048 0002 00 3K

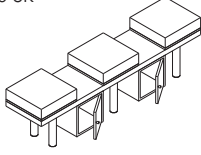

Ölçü
Dimension

Renk
Color Code

H D L
400 400 1800

STN.A

OTURMA GRUBU - T0006

SEAT GROUP - T0006
Main Code : U048 0006 00

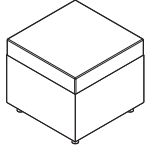

H D L
450 500 500

STN.A

OTURMA GRUBU - T0022

SEAT GROUP - T0022
Main Code : U048 0022 00

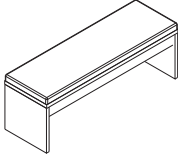

H D L
610 400 1250

STN.A

OTURMA GRUBU - T0035

SEAT GROUP - T0035
Main Code : U048 0035 00

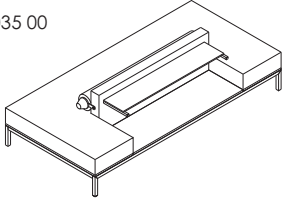

H D L
610 1060 2200

STN.A
STN.R

AYNA - T0005

MIRROR - T0005
Main Code : U053 0005 00

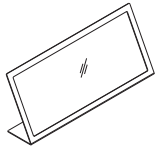

H D L
280 135 700

STN.R
FLA

AYNA - T0047

MIRROR - T0047
Main Code : U053 0047 00

* Option - Tekerlekli
= With wheels

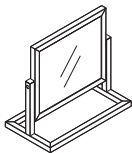

H D L
430 250 450

STN.R
FLA



UCGE SHOPFITTING & DESIGN

AYNA - T0070

MIRROR - T0070
Main Code : U053 0070 00

* Option - Tekerlekli
~ With wheels

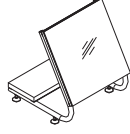

Ölçü Dimension			Renk Color Code
H	D	L	
455	505	450	STN.R FLA
H	D	L	
1850 1850 1850		600 700 900	FLA
2000 2000 2000		600 700 900	
H	D	L	
1900	500	570	STN.R FLA
H	D	L	
1450	550	530	STN.R FLA

AYNA - T0062

MIRROR - T0062
Main Code : U053 0062 00

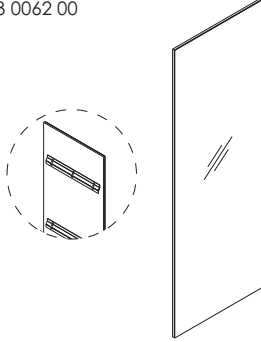

AYNA - T0051

MIRROR - T0051
Main Code : U053 0051 00

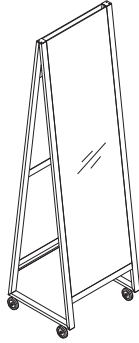

AYNA - T0069

MIRROR - T0069
Main Code : U053 0069 00

